

24" Combination LED TV/DVD

Installation & Operating Instructions - Please keep for future reference

529/9177

BUSH

LED24970DVDFHDS



 SAORVIEW
APPROVED

 DVD
VIDEO

 DVB
Digital Video
Broadcasting

 HDMI
HIGH DEFINITION MULTIMEDIA INTERFACE

IMPORTANT - Please read these instructions fully before installing or operating

These instructions contain important information which will help you get the best from your television and ensure safe and correct installation and operation.

**For any help concerning set up and use of your TV please call the
Customer Helpline: 0345 604 0105**

Lines open: 9am - 8pm Monday to Saturday and 10am - 4pm Sunday

For any help concerning set up and use of your TV please call the Customer Helpline: 0345 604 0105

Issue 1 - 9/2/11

Contents

Contents	2	Connections	18
Contents	3	Back connections explained	18
Preparation	4	Left side connections explained	19
Intended Use	4	HDMI Connections	20
Power source	4	SCART Connections	20
Positioning the TV	4	VGA Connections	20
Power cord and plug	4	Side AV Connections	21
Moisture and Water	5	Using a Conditional Access Module	21
Ventilation	5	USB Connections	22
Heat sources and Flames	5	Basic Features	23
Headphone Volume	5	How to navigate menus - Selecting source	23
Wall Mounting (optional)	5	Electronic programme guide (EPG)	23
LCD Screen	5	General Operation	24
Cleaning	5	Displaying Subtitles	24
Handling Discs	5	Zoom Modes	24
Cleaning Discs	5	Using Main Menu Screen	24
Batteries	5	Configuring Date/Time Settings	24
Replacement Parts	6	Source Settings	24
Servicing	6	Audio Language	24
Taking out of service and storing	6	Basic Features	25
Connection to a Television Distribution System (Cable TV etc.) from Tuner	6	Navigating Channel List	25
Symbols in this Instruction Book	6	Moving a Channel	25
Getting Started	7	Deleting a Channel	25
TV - Features	8	Renaming a Channel	25
DVD - Features	8	Locking a Channel	25
Viewing remote control - TV	9	Sorting Channel List	25
Viewing remote control - DVD	10	DVD Mode Disc Playback	26
Getting Started	11	Environmental Information	26
Attaching the Stand	11	Language Settings	27
Getting Started	12	Language Settings	27
TV - Control buttons (left side)	12	Other Functions and Features	28
DVD - Control buttons (right side)	12	Favourite Mode	28
Aerial connection	13	Conditional Access	28
Power connection	13	Setting Sleep Timer	28
Remote control - Inserting batteries	13	Setting Programme Timers	28
Wall Mounting	13	Editing a Timer	28
Switching the TV On and Off	13	Deleting a Timer	28
Switching the TV On	13	Picture Controls	29
Switching the TV Off	13	Configuring Picture Settings	29
Operation using TV control buttons	14	Operating Picture Settings Menu Items	29
Operation using Remote control buttons	14	Picture Settings Menu Items	29
How to watch a DVD	15	PC Picture Settings Operation	29
Notes on DVD Playback	15	Sound and Source Settings	30
Getting Started	16	Configuring Sound Settings	30
DVD Controls	16	Sound Settings Menu Items	30
Initial set up	17	Configuring Source Settings	30
General operation	17	Other Controls	31
Information Banner	17	Operation	31
		Other Settings Menu Items	31

Contents

Advanced Features	32	Specifications	38
Media Browser	32	Other Information	39
Starting Media Browser	32	Plug replacement - UK and Ireland only	39
Media Browser Configuration	32	Other Information	40
Operation	32	Product Support	41
View Style	32	Trouble shooting	41
Slide Show Interval	32	DVD Mode Supported file formats	42
Show Subtitle	32	Disposal information	42
Subtitle Language	32	Compatible disc types	43
Subtitle Position	32	Supported DVI Resolutions	43
Subtitle Font Size	32	Supported File Formats for USB Mode	44
Loop / Shuffle during Playback	32	AV and HDMI Signal Compatibility (Input Signal Types)	44
Media Browser - continued	33	Definition of important terms - DVD	45
Viewing Videos via USB	33	Definition of important terms - TV	46
Video Playback Screen	33	Software Upgrade	47
Subtitle Time Correction	33	Licence Notifications	47
Viewing Photos via USB	33	Guarantee	48
Displaying Photos in Slideshow Mode	33		
Playing Music via USB	33		
Setting the channels	34		
Accessing Installation Menu	34		
Automatic Channel Scan (Retune)	34		
Manual Channel Scan	34		
Analogue Fine Tune	34		
First Time Installation	34		
Clear Service List	34		

Model number

ALBA DVB-T LED24970DVFHDS



CAUTION
RISK OF ELECTRIC SHOCK
DO NOT OPEN



CAUTION: TO REDUCE THE RISK OF ELECTRIC SHOCK, DO NOT REMOVE COVER (OR BACK). NO USER-SERVICEABLE PARTS INSIDE. REFER SERVICING TO QUALIFIED SERVICE PERSONNEL.



The lightning flash with arrowhead symbol, within an equilateral triangle, is intended to alert the user to the presence of uninsulated “dangerous voltage” within the product’s enclosure that may be of sufficient magnitude to constitute a risk of electric shock of persons.



The exclamation point within an equilateral triangle is intended to alert the user to the presence of important operating and maintenance (servicing) instructions in the literature accompanying the appliance.

Preparation

Place the device on a solid even surface. For ventilation, leave a free space of at least 10 cm all around the set. To prevent any fault and unsafe situations, do not place any objects on top of the set. Use this device in moderate climates.

Operation temperature and operation humidity: 5°C up to 45°C, 85% rel. humidity max. (not blocking ventilation openings).

Intended Use

This device is used to receive and display TV programmes, as well as to play CDs and DVDs (see “This device compatible disc types”). The different connection options make an additional expansion of the reception and display sources possible (various external devices). This device is only suitable for dry interior use. This appliance is intended solely for private domestic use and may not be used for industrial and commercial purposes. We exclude liability in principle, if the device is not used as intended, or unauthorized modifications have been made. To operate your LCD TV in extreme ambient conditions may cause the damage of the device.

⚠ WARNING: Never let people (including children) with physical, sensory or mental abilities or lack of experience and / or knowledge unsupervised use electrical device!

Children may not recognize dangers right! The swallowing of batteries can be fatal. Keep batteries always out of reach of small children. If a battery is swallowed, seek immediate medical attention. Keep the packaging films out of reach of children, there is a risk of suffocation.

Power source

- The TV should be operated only from a 220-240V AC, 50 Hz outlet.
- **⚠ Warning:** Do not leave your TV in standby or operating mode when you leave your house.

Positioning the TV

- For ventilation, please leave a clear space of at least 10cm all around the TV.
- **Do not** block the ventilation openings.
- **Do not** place the TV on sloping or unstable surfaces, the TV may tip over.
- To prevent damage to the TV, **do not** place any objects on top of the TV.
- Only use the TV in moderate climates.

Power cord and plug

- The power cord plug should be easily accessible. In case of storms and lightning, when going on holiday, or when the TV is not used for a long period of time disconnect the power cord from the mains power socket.
- The mains plug is used to disconnect TV set from the mains and therefore it must remain readily accessible.
- **Do not** place the TV, furniture, etc. on the power cord or pinch the cord.
- Handle the power cord by the plug, **do not** unplug the TV by pulling the power cord.
- Never touch the power cord/plug with wet hands as this could cause a short circuit or electric shock.
- Never make a knot in the power cord or tie it with other cords.
- Power cords should be placed in such a way that they are not likely to be stepped on or driven over.
- A damaged power cord/plug can cause fire or give you an electric shock. When damaged it must be replaced, this should only be done by qualified personnel.



Moisture and Water

- **Do not** use this TV in a humid or damp place (avoid bathrooms, the sink in the kitchen, etc).
- **Do not** expose this TV to rain or water, as this may be dangerous.
- **Do not** place objects filled with liquids, such as flower vases, on top of the TV. Avoid from dripping or splashing.
- If any solid object or liquid falls into the cabinet, unplug the TV and have it checked by qualified personnel before operating it any further.

Ventilation

- The slots and openings on the TV set are intended for ventilation and to ensure reliable operation.
- To prevent overheating, these openings must not be blocked or covered in anyway.

Heat sources and Flames

- **Do not** expose the TV to direct sunlight or other heat sources.
- The TV should not be placed near to open flames and sources of intense heat such as an electric heater. 
- Ensure that no open flame sources, such as lighted candles, are placed on top of the TV.

Headphone Volume

- Excessive sound pressure from earphones and headphones can cause hearing loss, please take care.



Wall Mounting (optional)

- To prevent injury, this TV must be securely attached to the wall in accordance with the installation instructions (if the option is available).

LCD Screen

- Occasionally, a few non-active pixels may appear on the screen as a fixed blue, green or red point. Please note that this does not affect the performance of your product.
- Take care not to scratch the screen with fingernails or other hard objects.

Cleaning

- Before cleaning, unplug the TV from the wall socket.
- **Do not** use liquid or aerosol cleaners. Only use a soft, dry cloth.

Handling Discs

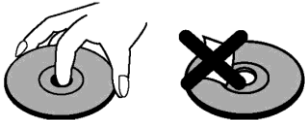
- To keep the disc clean, only handle the disc by its edge. **Do not** touch the surface. 
- **Do not** stick paper or tape on the disc.
- If the disc is contaminated with any substance like glue, remove before using it.
- **Do not** expose the disc to direct sunlight or heat sources such as hot air ducts, or leave it in a car parked in direct sunlight as the temperature can rise quickly and damage the disc.
- After playing, store the disc in its case.

Cleaning Discs

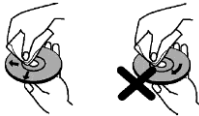
- Before playing, clean the disc with a cleaning cloth. Wipe the disc from the centre out. 
- **Do not** use solvents such as benzene, thinner, commercially available cleaners or anti-static spray intended for vinyl LPs.

Batteries

- **Warning:** Incorrect installation of batteries may cause battery leakage and corrosion, resulting in damage to the remote control. 
- **Do not** mix old and new batteries, or batteries of different types.
- **Do not** dispose of batteries in a fire.
- **Do not** dispose of batteries with normal household waste, take to a local recycling centre.
- **CAUTION:** Insert the batteries / rechargeable batteries in the correct polarity. Don't try to recharge non rechargeable batteries and under no circumstances throw them into fire. Danger of explosion. Do not use unequal batteries (old and new, Alkaline and carbon, etc.) simultaneously. If you will not use the device for a long time, remove the batteries and store the device in a dry and dust free place. Improper use of batteries may cause an explosion or leakage. If the batteries have leaked, use gloves and clean the appliance thoroughly with a dry cloth! Batteries should not be exposed to heat, such as sunshine, fire or the like.



Replacement Parts

When replacement parts are required, make sure that the service technician has used replacement parts, which are specified by the manufacturer or have the same specifications as the original one. Unauthorised substitutions may result in fire, electrical shock or other hazards.

Servicing

- **Warning:** Risk of exposure to radiation from class 1/class 3b visible and invisible laser beams. **Do not** open the TV and stare directly into beam.

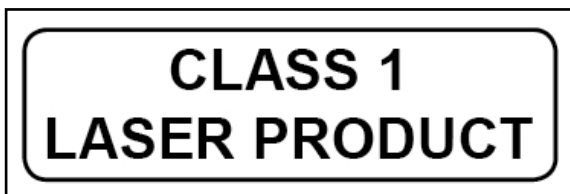

- **Warning:** Risk of electric shock, **do not** attempt to repair, service or modify this TV yourself. Contact the manufacturer, their approved service agent or the **Customer Helpline: 0345 604 0105**.

Taking out of service and storing

Unplug the TV from the mains and pack the TV in an appropriate cardboard box. Remove the batteries from the remote control and pack the remote control to the TV set.

 **NOTE:** The TV set should be stored in a dry and dust-free room.

Connection to a Television Distribution System (Cable TV etc.) from Tuner

Device connected to the protective earthing of the building installation through the mains connection or through other apparatus with a connection to protective earthing-and to a television distribution system using coaxial cable, may in some circumstances create a fire hazard.

Connection to a cable distribution system has therefore to be provided through a device providing electrical isolation below a certain frequency range (galvanic isolator, see EN 60728-11).

Symbols in this Instruction Book

The following symbols are used in the Instruction Book as a marker for restrictions and precautions and safety instructions. Note such information for security reasons.

WARNING

If you do not pay attention to such a marked warning, it can cause serious injury or death. Note these warnings strictly, in order to ensure a safe operation.

CAUTION

Such a precaution is marked, you should take up or note, to avoid injury or property damage. Note these instructions strictly, in order to ensure a safe operation.

IMPORTANT

Warnings on the appliance and restrictions are displayed like this. Read this information strictly in order to operate the system correctly and avoid damage.

 **NOTE:** Information about the operation and additional explanations are marked like this. To be aware of such information is recommended to ensure that the functions can be used optimally.

WARNING

This is a class A product. In a domestic environment it could cause radio interference, in which case it may require the user to take appropriate action.

Getting Started

The Argos Technical Helpline is here to help

Technical experts are available 7 days a week

- **Simple help and advice on setting up your digital equipment (image).**
- **Guidance on connecting other devices to your television such as a DVD player, Sky, home cinema system or a games console.**
- **Order spare parts, including that lost remote control.**
- **Any other technical issues you may need assistance with.**

Call us today: 0345 604 0105

Local call rates applies*

Lines open 9am-8pm Monday to Saturday and 10am-4pm Sunday.

*Calls to Argos enquiry lines may attract a charge and set up fee from residential lines depending on your call plan/tariff. Mobile and other providers costs may vary, see www.bt.com/pricing for details.

For Security and training purposes, telephone calls to and from customer service centres maybe recorded and monitored. Calls from Republic of Ireland will attract international call charges.

Getting Started

TV - Features

- Remote controlled colour LCD TV.
- Fully integrated Terrestrial digital TV (DVB-T - MPEG2, MPEG4)
- HDMI connectors for digital video and audio. This connection is also designed to accept high definition signals.
- USB input.
- 1000 programmes (analogue+digital).
- OSD menu system.
- Integrated tuner MPEG 2, MPEG 4 compatible.
- Scart socket for external devices (such as video, video games, audio set, etc.).
- Stereo sound system. (German+Nicam)
- Teletext, fastext, TOP text.
- Headphone connection.
- Automatic programming system.
- Forward or backward manual tuning.
- Sleep timer / Child lock.
- Automatic sound mute when no transmission.
- NTSC playback.
- AVL (Automatic Volume Limiting).
- Auto power down.
- PLL (Frequency Search).
- PC input.
- Plug&Play for Windows 98, ME, 2000, XP, Vista, Windos 7.
- Game Mode

DVD - Features

- DVD / CD / CD-R / CD-RW / MP3 / JPEG / MPEG playback.
- NTSC / PAL playback (according to disc content).
- LPCM audio via coaxial and optical digital audio outputs (optional).
- Multi-Audio (up to 8) support (according to disc content).
- Multi-Subtitle (up to 32) support (according to disc content).
- Multi-Angle (up to 9) support (according to disc content).
- 8 level parental control.
- Fast forward and rewind - 5 different speeds: 2x, 4x, 8x, 16x, 32x.
- Slow motion playback - 4 different speeds: 1/2x, 1/4x, 1/8x, 1/16x forward.
- Frame by frame forward playback.
- Search Mode
- Repeat
- Coaxial audio output (optional).
- Copied disks may be incompatible.

Accessories included

Remote Control
Batteries: 2 x AAA
Instruction Book
Quick Start Guide
Side AV Connection Cable

Optional Accessories

Wall mount bracket

 **NOTE:** You should check the accessories after purchasing. Make sure that each accessory is included.

Getting Started - TV

Viewing remote control - TV

1. Standby
2. Image size
3. Sleep timer
4. Number buttons
5. Return / Exit / TXT Index
6. Cursor up / TXT up page
7. Cursor left
8. Programme up / Page down (in DTV mode)
9. Programme down / Page up (in DTV mode) Mono-
10. Stereo / Dual I-II Swap
11. Electronic programme guide (in DTV mode)
12. Info / TXT reveal
13. Source selection
14. Picture mode selection
15. Red / Sound
16. Green / Picture
17. Yellow / Feature / Current language
18. Blue/Install
19. Menu
20. Cursor right / TXT Sub page
21. OK / Select
- 22.
23. Cursor down / TXT Down page
24. Volume up
25. Volume down
26. Subtitle (in DTV mode) / TXT Subtitle
27. Mute
28. Teletext / Mix
29. FAV (Favourite Selection) (in DTV mode)
30. Media Player buttons

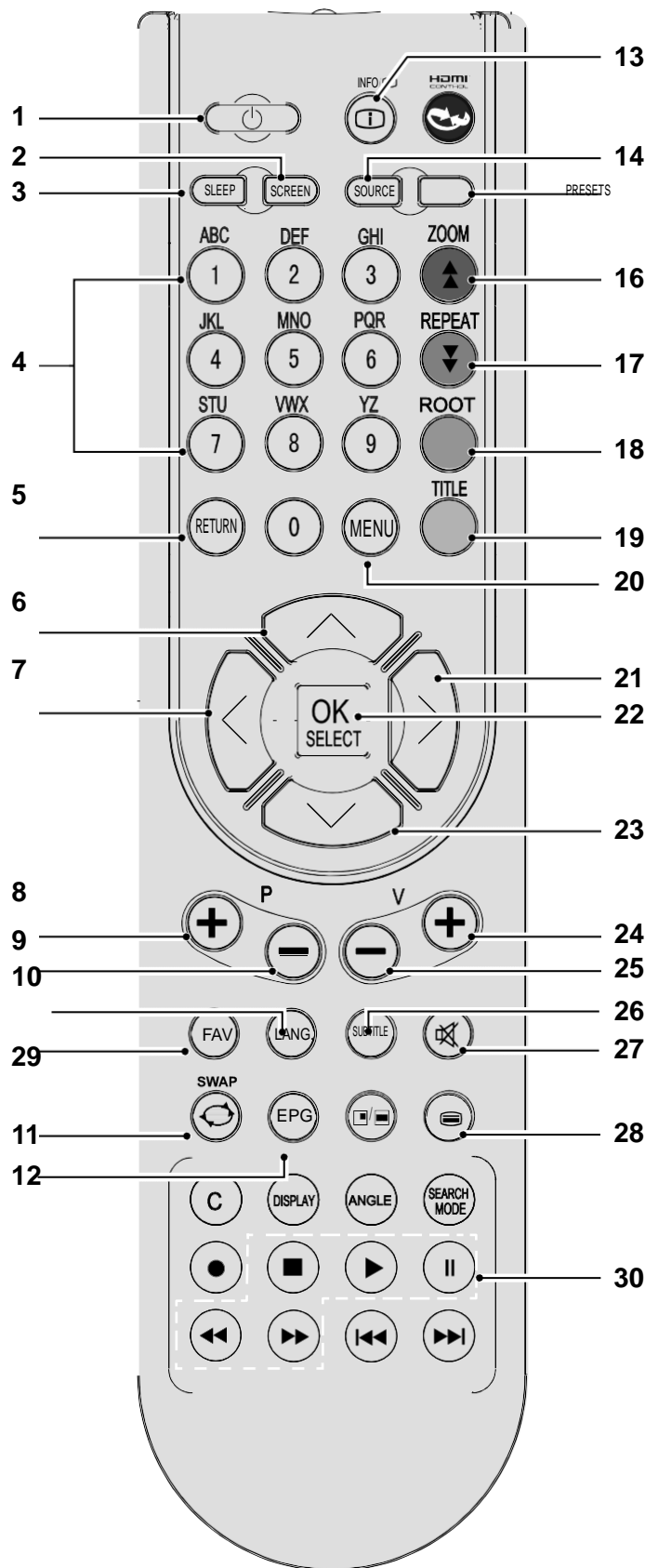

NOTE: Remote Control buttons that are not indicated with a number can not be used in TV mode.

The Remote Control range is approximately 7m / 23ft.

Viewing remote control - DVD

1. Standby
2. Number buttons
3. Return back
4. Language selection (Set language)
5. Display time / DVD menu
6. Clear
7. Stop
8. No function
9. Rapid Reverse
10. Rapid advance
11. Info
12. Zoom
13. Repeat
14. Root
15. Title
16. Menu
17. Navigation Buttons
18. OK / Select
19. Subtitle
20. Angle
21. Search mode
22. Play
23. Pause
24. Skip next
25. Skip previous

 **NOTE:** Remote Control buttons that are not indicated with a number can not be used in DVD mode.

The Remote Control range is approximately 7m / 23ft.

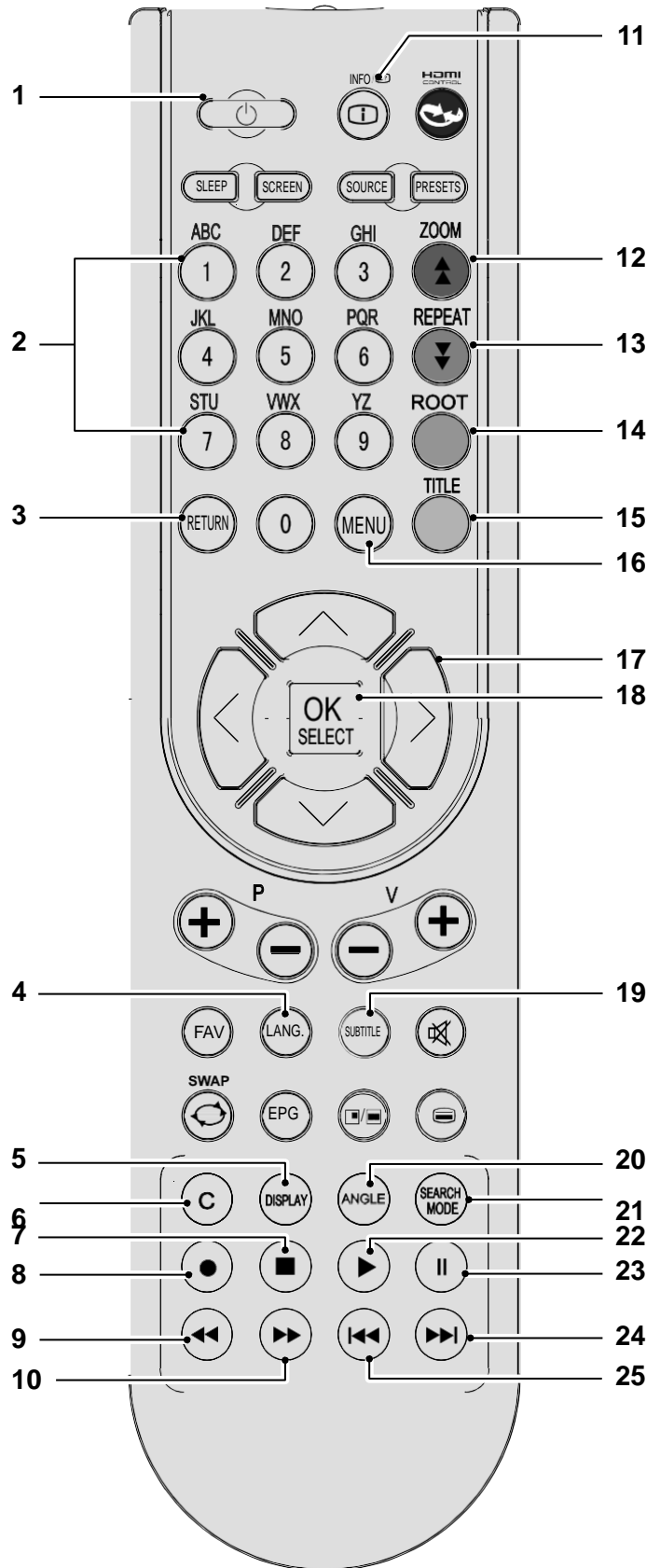

Attaching the Stand

1. Stand is placed on a flat surface (fig.1).

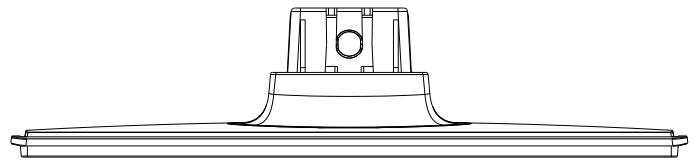

fig.1

2. The product is held over the stand so that it coincides with the stand mounting point and then it is left to be mounted with its own weight (fig.2).

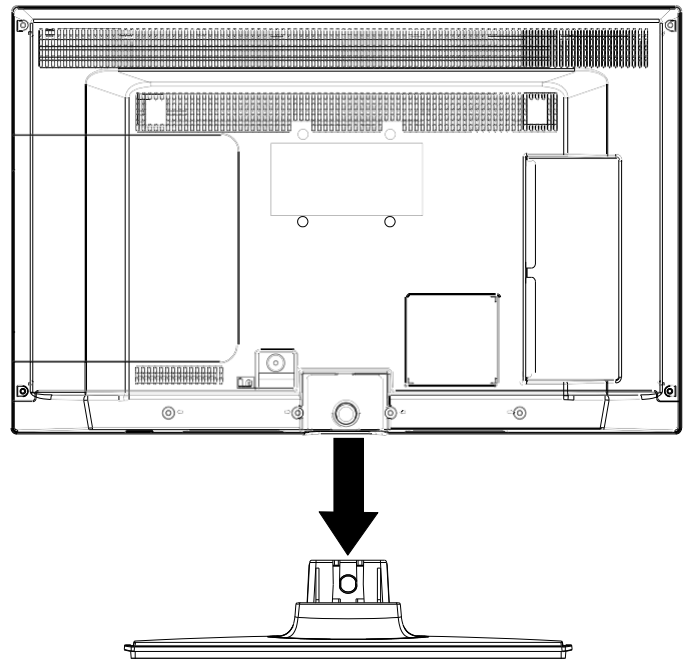

fig.2

TV - Control buttons

1. Up (+) button

Increases the volume and moves up a channel.

2. Down (-) button

Decreases the volume and moves down a channel.

3. Programme / Volume / AV selection (P/V/AV) button

Changes the operation of “Up” and “Down” buttons.

 **NOTE:** You can use +/- buttons to change volume. To change channels, press P/V/AV button once and then use +/- buttons. If you hold the P/V/AV button for a few seconds, the source OSD (On Screen Display) will be displayed.

4. Standby (⏻) button

Turns the TV on when in standby mode or turns the TV off into standby mode.

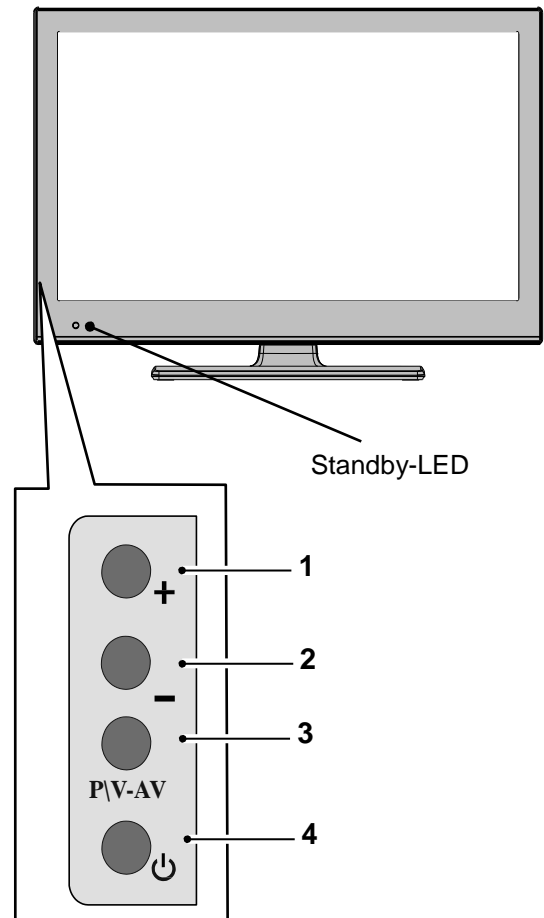

DVD - Control buttons (right side)

5. Disc loader

6. Play / Pause (▶/⏸) button

Plays / pauses the disc. When DVD menu (root menu) is active, this button functions as “button select” (selects the highlighted item in menu) if this is not prohibited by the disc).

7. Stop / Eject (■ / ⏏) button

Stops the disc playing / Ejects or Loads the disc.

 **NOTE:** You cannot eject the disc via the remote control. To eject while playing a file; you should **press** the **STOP** button “■ / ▶” (on the TV) **three times**.

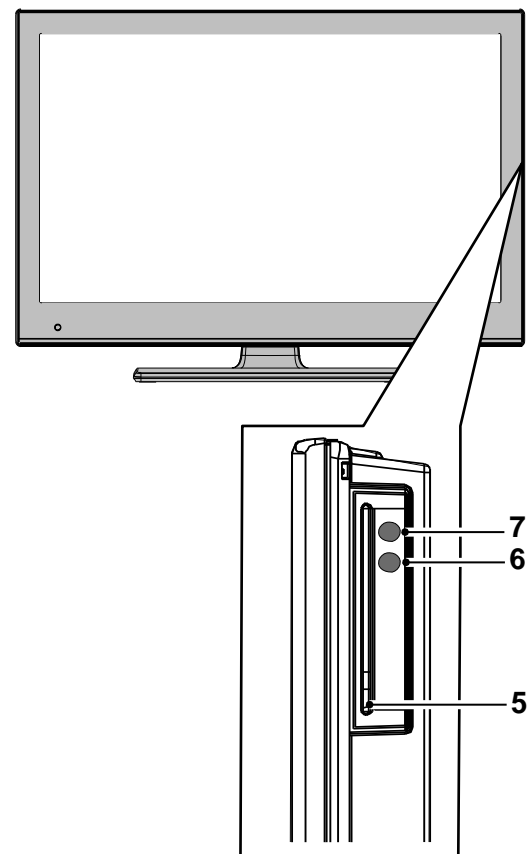

Aerial connection

Connect the “aerial” or “cable TV” plug to AERIAL INPUT (ANT.) socket located on the back of the TV (fig.1).

Power connection

IMPORTANT : The TV set is designed to operate on 220-240V AC, 50 Hz.

Please note: After unpacking, allow the TV to reach ambient room temperature before connecting the TV to the mains power socket.

Connect the power cord plug to the mains power socket.

The LED on the front of the TV then lights up, this indicates that the TV is in ‘Standby’ mode.

Remote control - Inserting batteries

Remove the battery cover on the back of the remote control, gently push down and pull backwards at the same time as shown.

Insert two **AAA/R3** or equivalent type batteries. Ensure the batteries are inserted the correct way and replace the battery cover (fig.2).

NOTE: When the remote control is not going to be used for long periods of time, the batteries should be removed. Otherwise the remote control may be damaged, caused by battery leakage and corrosion.

Wall Mounting

When wall mounting please ensure you use a compatible wall mount (not supplied). This TV conforms to the VESA mounting specifications and is 75 x 75 mm.

Switching the TV On and Off



Switching the TV On

With power cord plug connected to the mains power socket, the TV is in ‘Standby’ mode.

To switch the TV on from standby mode:

Connect the power cord to the 220-240V AC 50 Hz. Then the standby LED lights up. (The led will blink during the standby On/Off)

To switch on the TV from standby mode either:

- Press the “” button, P+ / P- or a numeric button on the remote control.
- Press the “”, - or + button of the TV.

By either method the TV will switch on.

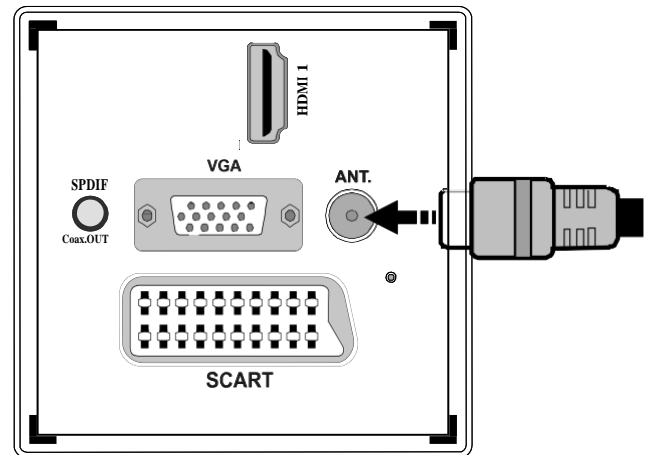
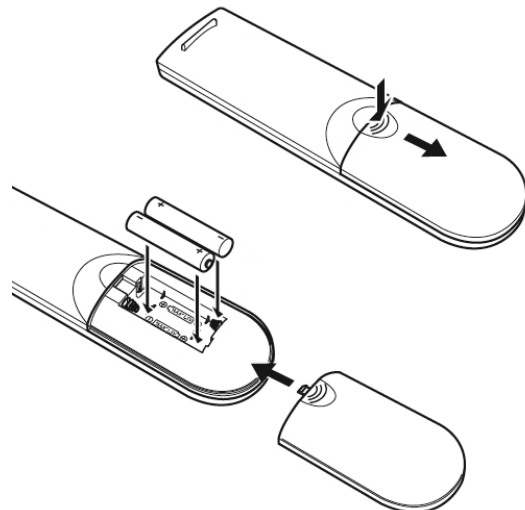



fig.1



AAA/R3 x 2
Batteries

fig.2

Switching the TV Off

Press the “” button on the remote control or press the “” switch on the TV, the TV will switch to standby mode.

To turn off the TV completely, remove the power cord plug from the mains power socket.

NOTE: When the TV is in standby mode, the standby LED can blink to indicate that features such as Standby Search, Over Air Download or Timer is active.

NOTE: If you switch on your TV via P +/- buttons on the remote control or +/- on the TV set, the programme that you were watching last will be reselected.

Operation using TV control buttons

The main menu OSD (On Screen Display) cannot be displayed using the TV control buttons.

The **+/-** buttons will function as volume up/down as default. Even if you set other functions for these buttons, the **+/-** buttons will return to volume control after a short while.

Volume Setting

Press **+/-** buttons to increase or decrease volume.

Programme Selection

Press **P/V/AV** button once and then use **+/-** to select the next or previous programme.

AV Mode

Hold the **P/V/AV** button for a few seconds, the "Source" OSD will be displayed.

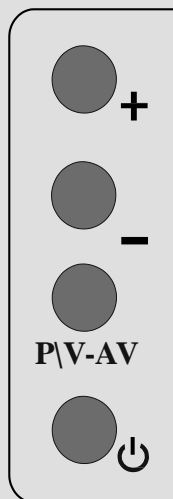

Operation using Remote control buttons

The remote control is designed to control all the functions of the model you selected.

Volume Setting

Press "**V +**" button to increase the volume. Press "**V -**" button to decrease the volume. A volume level scale (slider) will be displayed on the screen.

Programme Selection (Previous or Next Programme)

Press **P-** button to select the previous programme. Press **P+** button to select the next programme.

Programme Selection (Direct Access)

Press number buttons on the remote control to select programmes between 0 and 9. The TV will switch to the selected programme.

To select programmes between 10-500 (IDTV) or 10-199 (analogue), press the number buttons consecutively.

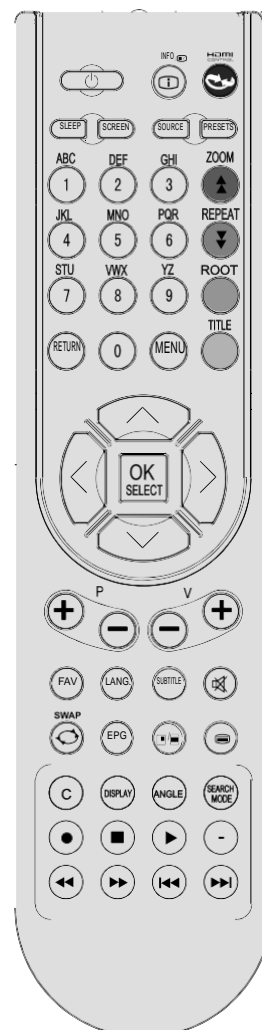

How to watch a DVD

1. Press the Power Button “**⏻**” on the TV or remote control.
2. Switch to DVD source using the “SOURCE” button on the remote control.
3. Insert a disc into the loader.

The disc **MUST** be facing you when looking at the TV screen (fig.3).

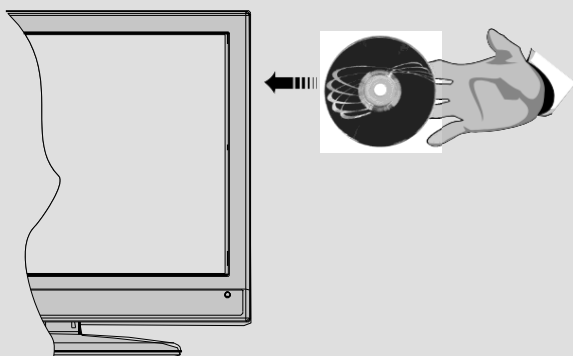

Most discs will be automatically loaded and play will start automatically if the disc does not have any menus recorded on it.

If play does not start automatically, press the play button “**▶**” on the remote control, or the play button “**▶ / II**” on the right side of the TV.

A menu may appear on the TV screen after a few moments or the film may start immediately after the Film/TV Company introduction. This will depend on the disc content and may differ on each disc.

NOTE: Steps 4 and 5 are only available when a menu is recorded on the disc.

4. Press the navigation buttons “**^**”, “**v**”, “**<**” or “**>**” or the number button/s to select the required title.
5. Press the **OK** button. The selected item starts to play.

Notes on DVD Playback

- a. No sound will be heard during Rapid advance or Rapid reverse.
- b. No sound will be heard during Slow motion play.
- c. Reverse Slow motion play is not available.
- d. In some cases, the subtitle language will not be changed immediately to the selected one.
- e. When the preferred language will not select, even after pressing the button several times, it means the language is not available on the disc.
- f. When the DVD player is restarted or the disc is changed, the subtitle selection is automatically changed back to the initial settings.
- g. If a language is selected that is not supported by the disc, the subtitle language will automatically be set to the disc's priority (default) language.
- h. Usually a ‘circulation’ will happen while switching to another language, this means you can cancel the subtitle by pressing the same button a number of times until “Subtitle Off” appears on the screen.
- i. When the power is turned on or the disc is removed, the language heard will be the one selected at the initial settings.
- j. Some DVDs may not contain root and/or title menus.
- k. Reverse stepping is not available.
- l. For reference: If you attempt to enter a number greater than the total time of the current title, the time search box disappears and “Input Invalid” message appears on top-left corner of screen.
- m. The slide show is disabled when the ZOOM mode is on.

DVD Controls

You can operate DVD, movie CD, music or picture CD's content by using the correct buttons on your remote control. Below are main functions of commonly used remote control buttons.

Buttons on Remote Control	DVD Playback	Movie Playback	Picture Playback	Music Playback
▶	Play	Play	Play	Play
⏸	Pause	Pause	Pause	Pause
■	Stop	Stop	Stop	Stop
⏮ / ⏭	Skip backward / forward	Skip backward / forward	Previous / Next	Previous / Next
◀ / ▶	Shifts the zoomed picture left or right (if available).			
∨ / ∧	Highlights a menu item / Shifts the zoomed picture up or down (if available).			
⏮ / ⏭	Rapid advance / Rapid reverse			
ANGLE	Views the scene from different angles (if available)		Changes slide effect (depends on the content)	X
C	Clears digit (if available).			
DISPLAY	Displays time / Views main setup menu			
INFO	Time counter mode selection (during playback). Press repeatedly to switch between modes.			
LANG.	Auto language		X	X
MENU	Displays TV menu.			
OK / SELECT	Enter / View / Play			
REPEAT	Displays repeat options.			
RETURN	Returns back to the previous menu (if available).			
ROOT	Goes back to the root folder (if available).			
SEARCH MODE *	Direct selection of scenes or time.		Selects the desired file.	Selects the desired file.
SUBTITLE	Subtitle on-off. Press repeatedly to switch between subtitle options.		X	X
SWAP	Media source selection.			
TITLE	Displays disc menu (if available).	Displays disc menu (if available).	X	X
MENU	Zooms picture. Press repeatedly to switch between zoom options.			

Other Functions – Button Combinations (During playback)

⏸ + ⏭	Slow forward
(⏸ + ⏭) + ⏮	Sets slow forward speed
⏭ + ⏭	Sets rapid advance speed
⏮ + ⏮	Sets rapid reverse speed
■ + ■	Confirms stop command
⏸ + ⏭	Press repeatedly to advance manually

(*) You can switch to a title by pressing number buttons directly. You need to press 0 and then digit key to switch one digit titles (*example: to select 5, press 0 and 5*).

Getting Started

Initial set up

When turned on for the first time, language selection message is displayed (fig.1). Press the “^” or “v” button to highlight the required language, press **OK** button to select. “First Time Installation” appears. Use “<” or “>” button to set the required country, and press “v” button to select “Teletext Language”. Use “<” or “>” button to set the “Teletext Language” and select “Scan Encrypted” using “^” or “v” button. Set “Scan Encrypted” using “<” or “>” button (fig.2).

Press **OK** button on the remote control to continue and the confirmation screen will be displayed on the screen (fig.3). To start automatic select **Yes** (to cancel select **No**), highlight the item required using the “<” or “>” button and press **OK** button to select. The search will start (fig.4).



IMPORTANT: Do not turn off the TV while “First Time Installation” is in operation.

After all the available stations are stored, Channel List will be displayed on the screen. If **LCN (*)** is available in your country, a message appears on the screen which asks you if you want to sort the channels according to LCN. In some countries, the order of the channels is arranged automatically by the broadcaster. This is called logical channel number (LCN). If the selected country has LCN support, the channels will be enumerated one by one, beginning from number 1. You cannot move any programme to a position after the last saved one. If you try to do this, both programmes will change their places. If LCN support is not available, you can move the channels as you wish.

Press **OK** button to quit channel list and watch TV.

(*) LCN is the Logical Channel Number system that organizes available broadcasts in accordance with a recognizable channel sequence.

Source Selection

Press the **SOURCE** button on the remote control for switching between the sources.

Information Banner

Whenever you change channel using the **P-/P+** buttons or the numeric buttons, the TV displays the broadcast picture along with an information banner at the bottom of the screen. The information banner can be displayed at any time while watching TV by pressing the **INFO** button on the remote control (fig.5).

Hint: Not all channels broadcast the programme data. If the name and time of the programme are not available, then information banner will be displayed with blanks.

If the selected channel is locked, you must enter the correct four-digit numeric code to view the channel (default code is **0000**). “Enter PIN” will be displayed on the screen in such a case.



(fig.1)



(fig.2)

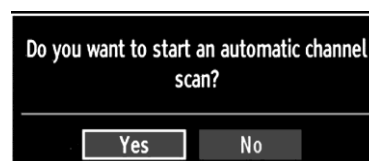

(fig.3)



(fig.4)



(fig.5)

Back connections explained

1. SCART socket

Inputs or outputs for external devices. Connect the SCART cable between the SCART socket on the TV and the SCART socket on the external device (decoder, VCR or DVD player) (see page 00).

NOTE: If an external device is connected via the SCART socket, the TV will automatically switch to AV mode. When receiving DTV channels (Mpeg4 H.264) or while in Media Browser mode, output will not be available via the scart socket.

2. HDMI Input

Connects a device that has an HDMI socket. The TV can display High Definition pictures from devices such as a High Definition Satellite Receiver or DVD Player. These devices must be connected via the HDMI sockets or Component Socket. No sound connection is needed

connection (see page 00).

3. PC Input (VGA)

Connects a personal computer to the TV. Connect the PC cable between the PC INPUT on the TV and the PC output on the PC. You can use the PC input to allow YPbPr signal connection with a device that has component output. Connect the YPbPr to PC cable between the PC INPUT on the TV and the component video outputs of the device.

4. RF Input (ANT.)

Connects to aerial (antenna) or cable TV. If you use a decoder or a media recorder, you should connect the aerial cable through the device to the TV with appropriate aerial cable (see page 00).

NOTE: When using the wall mounting kit (optional), we recommend that you plug all your cables into the back of the TV before mounting on the wall.

5. S/PDIF Coaxial Out

Outputs digital audio signals of the currently watched source.

Use an SPDIF coaxial cable to transfer audio signals to a device that has S/PDIF input.

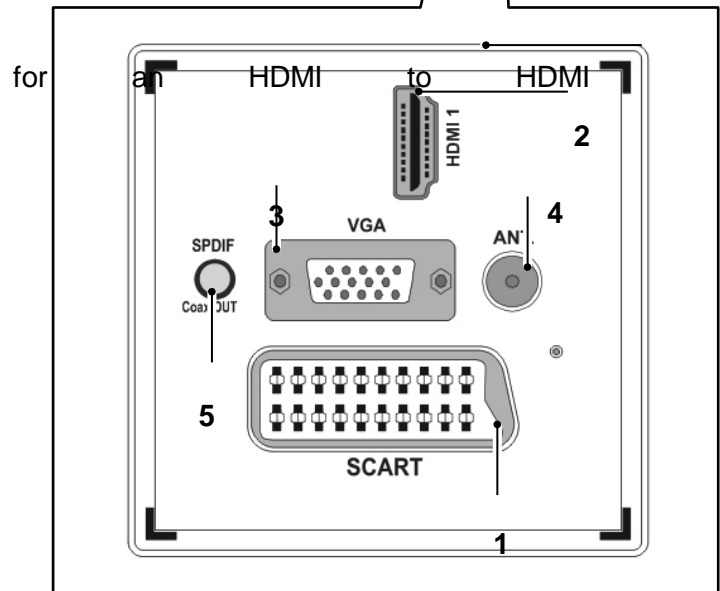
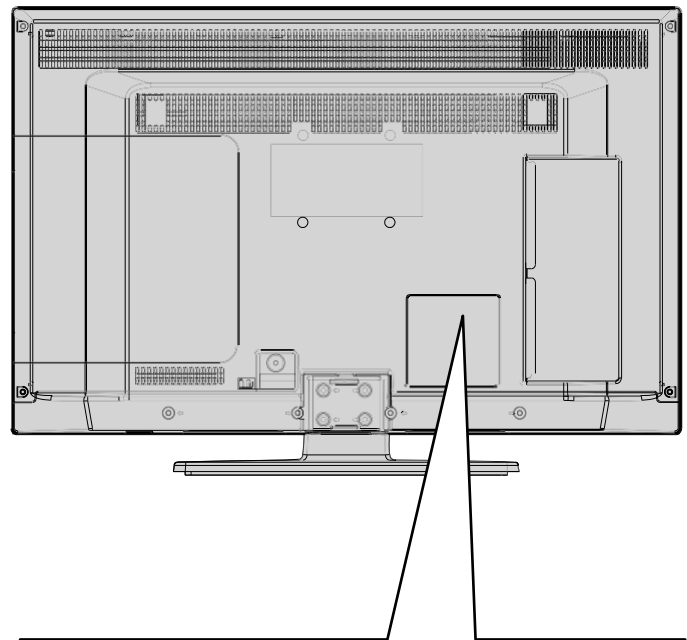

Left side connections explained

6. CI Slot

Used to insert a CI card. A CI card allows you to view all the channels that you subscribe to. For more information, see “Conditional Access” section.

7. USB Input

To connect devices to the TV, providing fast data exchange. USB will only function in DTV mode.

Use an SPDIF coaxial cable to transfer audio signals to a device that has S/PDIF input.

8. Side audio-video input

This input is used for connecting video and audio signals of external devices. To make a video connection, you must use the supplied AV connection cable for enabling connection. First, plug singular jack of the cable to the TV's Side AV socket. Afterwards, insert your video cable (not supplied) connector into the YELLOW input (located on the side with several connectors) of the supplied AV connection cable. Colours of the connected jacks should match.

To enable audio connection, you must use RED and WHITE inputs of the side AV connection cable. Afterwards, insert your device's audio cable connectors into the RED and WHITE jack of the supplied side AV connection cable. Colours of the connected jacks should match.

NOTE: You should use audio inputs of side AV connection cable (RED & WHITE) to enable sound connection when connecting a device to your TV by using a VGA connection (You need a VGA to YPbPr cable, not supplied).

9. Headphone

Headphone jack is used for connecting an external headphone to the system. Connect to the HEADPHONE jack to listen to the TV from headphones (optional).

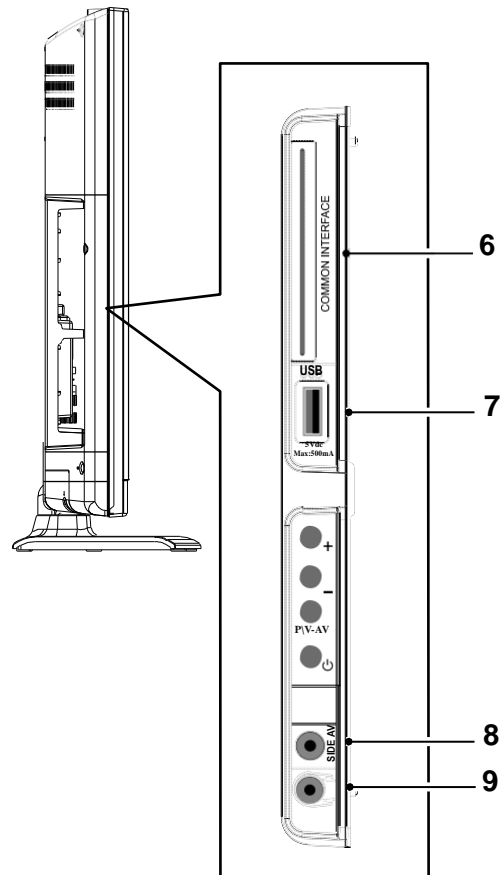

HDMI Connections

HDMI lets you enjoy high definition digital images and high quality sound by connecting the TV to external devices such as DVD players, set top boxes or gaming equipment (fig. 1).

Power off both the TV and the device before making any connections.

For more information, refer to your device's own instruction book.

After making the connection, switch to HDMI 1 or HDMI2 as a source, depending on which HDMI connector the external equipment is connected. See, **Input Selection** section for more information on changing sources.

 **NOTE:** HDMI cable is not supplied.

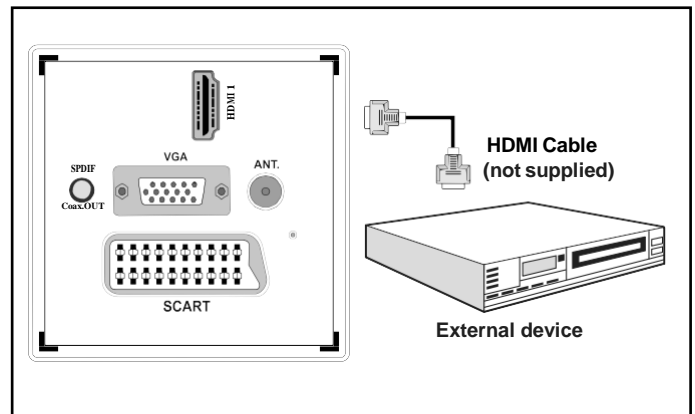



fig.1

SCART Connections

Most devices support SCART connection. You can connect a DVD recorder, VCR or decoder to the TV using the SCART socket (fig.2).

Power off both the TV and the device before making any connections.

For more information, refer to your device's own instruction book.

 **NOTE:** The Scart cable is not supplied.

 **NOTE:** If your external device has a **S-Video output**, it is possible to connect your external device with a **SCART-S-video adapter** (not included) to the scart input of the TV. First plug the SCART S-Video adapter to the SCART connector on your TV set. Then, connect a S-video cable to the SCART socket (via the Scart S-Video adapter) to the S-video output of your external device.

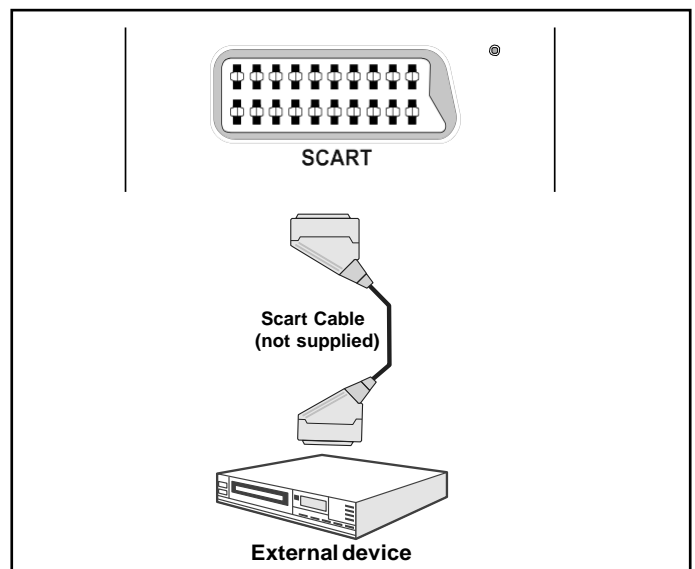

fig. 2

VGA Connections

You can connect a computer (PC) to the TV to display your computer's screen image on the TV.

Power up both computer and TV before making any connections.

Use a 15-pin D-sub display cable to connect a PC to the TV. Use an audio cable between audio inputs on the left side of the TV and audio output on your PC to enable sound connection (fig.3). You will need to use the supplied SIDE AV CONNECTION cable for connecting audio signals.

When the connection is made, switch "Source" to "PC-VGA". See "Input selection" section.

Set the resolution that suits your viewing requirements. Resolution information can be found in the "Appendix parts".

 **NOTE:** The cable is not supplied.

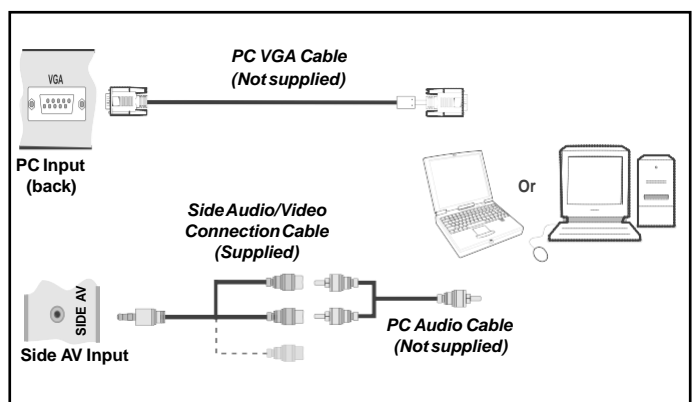

fig. 3

Side AV Connections

You must use the supplied SIDE AV connection cable for enabling SIDE AV connection.

1. Plug single jack of the cable to the TV's SIDE AV socket.
2. Insert your AV cable's (not supplied) connectors into the plural part of the SIDE AV connection cable (see illustration below). Colours of the connected jacks should match.
3. To enable audio connection, use an audio cable. Insert your device's audio cable's connectors into the plural part of the **SIDE AV connection cable**. Colours of the connected jacks should match (fig.1).
4. When the connection is made, switch to **SIDE AV** source.

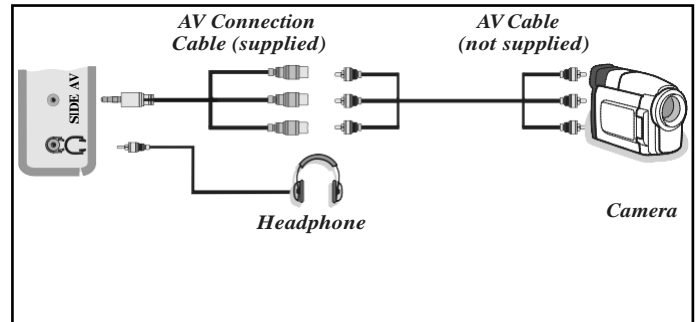

fig. 1

Using a Conditional Access Module

IMPORTANT: Insert or remove the CI module only when the TV is SWITCHED OFF.

In order to watch certain digital channels, a conditional access module (CAM) can be necessary. This module must be inserted in the CI slot of your TV.

1. Obtain the Conditional Access Module (CAM) and the viewing card by subscribing to a pay channel company, then insert those to the TV using the following procedure.
2. Insert the CAM and then the viewing card to the slot that is located in the terminal cover at the rear side of the TV.
3. The CAM should be correctly inserted, it is impossible to insert fully if reversed. The CAM or the TV terminal may be damaged if the CAM is forcefully inserted.
4. Connect the TV to the mains supply, switch on and then wait for few moments until the card is activated.
5. When no module is inserted, "**No Common Interface module detected**" message appears on the screen.

You can refer to the module instruction manual for details of the settings.

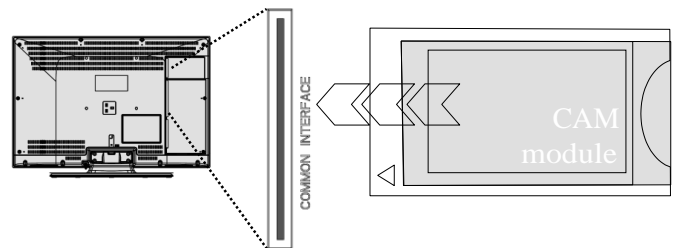

fig. 2

USB Connections

2.5" and 3.5" inch (hdd with external power supply) external hard disk drives are supported.

IMPORTANT

You should back up your files before making any connections to the TV set in order to avoid any possible data loss. Note that manufacturer will not be responsible for any file damage or dataloss.

It is possible that certain types of USB devices (e.g. MP3 Players) or USB hard disk drives/memory sticks may not be compatible with this TV.

The TV supports only FAT32 disk formatting. NTFS format is not supported. If you connect a USB disk with NTFS format, the TV will ask you to format the content. See the section, "Format Disk" in the following pages for more information on disk formatting.

Note that ALL the data stored on the USB disk will be lost and then the disk format will be converted to FAT32 in such a case.

USB Disk Connection

Plug your USB device to the USB input of the TV.

NOTE:

Plug or unplug your USB disk while the TV is switched off.

If you are going to connect a USB hard disk drive to the TV set, USB connection cable used between the disk drive and the TV should have a USB logo and should be as short as possible.

While formatting a USB hard disk that has 1TB (Tera Byte) or more file capacity, you can experience problems with the formatting process. In such a case, you should format the disk with your personal computer and the formatted disk type should be FAT32.

CAUTION:

Quickly plugging and unplugging USB devices, is a very hazardous operation. Especially, do not repeatedly quickly plug and unplug the drive. This may cause physical damage to the USB player and especially the USB device itself. Do not pull out USB module while playing or recording a file.

How to navigate menus - Selecting source

Once you have connected external devices to the TV, you can select and change the input source required.

To change Input Selection, use one of the following options:

Option a: Press the **SOURCE** button on the remote control to directly select required source.

Option b: Select **"SOURCES"** from the **"Settings"** menu using the **"^"** or **"v"** button.

Use the **"^"** or **"v"** button to highlight the required input and press the **">"** button to select.



Electronic programme guide (EPG)

Some, but not all channels send information about the current and next programmes. Press the EPG button to view the EPG menu.

It is able to get Information on all programmes for the next 7 days by means of the 7-DAY-EPG. All programmes on each channel will be displayed.

Info bar commands:

RED button - Shrink: reduces info boxes.

GREEN button - Expand: enlarges info boxes.

YELLOW button - Prev. day: displays programmes from previous day.

BLUE button - Next day: displays programmes for next day (will move forward a day each time button is pressed).

INFO button - Details: displays, in detail information on programme selected.

OK button - Reminder: to view current selected broadcasts or set reminders for future programmes.

Number buttons - Jump: go to preferred channel directly using number buttons.

0 button - Search: to view "Guide Search" menu. Using this feature, you can search the programme guide database in line with the genre selected or with name match and on the day/s selected.

⌂ button - Now: jumps to the current broadcast (when viewing previous "Prev. day" or future "Next day" programmes).



EPG screen in regular mode

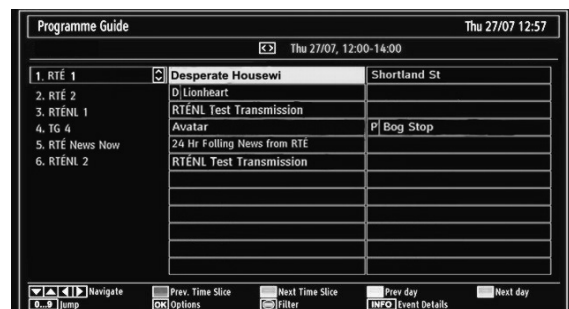

EPG screen in programme schedule



EPG screen in timeline schedule

General Operation

Displaying Subtitles

With digital terrestrial broadcasting (DVB-T), some programmes are broadcasted with subtitles.

1. Press **MENU** button to display main menu, highlight “**Settings**” then “**Language Settings**” menu using “**<**” or “**>**” or “**^**” or “**v**” button, press **OK** button to display “Language settings” menu.

2. Highlight “**Subtitle**” in “**Language settings**” menu using “**^**” or “**v**” button. Use “**<**” or “**>**” button to set Subtitles to the desired language.

 **NOTE:** You can directly press **SUBTITLE** button to enable or disable subtitles.

Zoom Modes

Programmes can be watched in different picture formats, depending on the transmission received.

You can change the aspect ratio (image size) of the TV for viewing the picture in different zoom modes.

Press **SCREEN** button repeatedly to change the image size. Available zoom modes are; Auto, 16:9, Subtitle, 14:9, 14:9 Zoom, 4:3, Panoramic and Cinema.

 **NOTE:** You can shift the screen up or down by pressing “**v**” / “**^**” buttons while picture zoom is selected as panoramic, 14:9 Zoom, Cinema or Subtitle. This is only possible as long as the display of the screen format is displayed.

Using Main Menu Screen

1. Press **MENU** button to display main menu, highlight the desired control icon using “**<**” or “**>**” or “**^**” or “**v**” button, press **OK** button to display menu contents.

2. Highlight an option inside a menu screen by using “**^**” or “**v**” button.

3. Use “**<**” or “**>**” button to set an option.

4. If “**OK**” box is displayed next to a menu setting, press “**OK**” to display sub-menu screen.

Changes are automatically stored. Press “**MENU**” to exit.

 **NOTE:** See **Picture, Sound, Settings** and **Installation Control** sections on pages **16-18** for learning the functions of menu items.

Configuring Date/Time Settings

1. Select **Date/Time** in the Settings menu to configure Date/Time settings.
2. Press **OK** button.

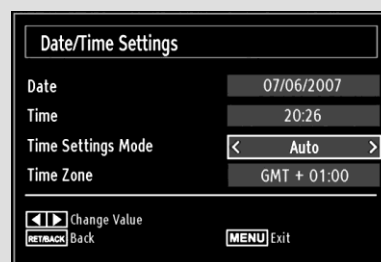

3. Use “**^**”, “**v**” and “**<**”, “**>**” buttons to set the options. Some items might be available to be set due to the selected modes.

Source Settings

You can enable or disable selected source options. When set, the TV will not switch to the disabled source options when “**SOURCE**” button is pressed.

1. Select “Sources” in the “Settings” menu and press “**OK**” button.
2. Press “**^**”, “**v**” buttons to select a source.
3. Use “**<**”, “**>**” button to enable or disable the selected source.

Audio Language

If there is a programme that is broadcasted with multi-channel sound and offers different languages, you can choose the audio language. Press **LANG.** button to select between available options.

Channel management

The TV sorts all stored stations in the Channel List. You can edit this channel list, set favourites or set active stations to be listed by using the Channel List options.

Press **MENU** button to view main menu. Select Channel List item by using “**<**” or “**>**” button. Press **OK** to view menu contents.



Select **Edit Channel List** to manage all stored channels. Use “**^**” or “**v**” and **OK** buttons to select “**Edit Channel List**”.



Navigating Channel List

1. Press “**^**” or “**v**” button to select previous or next channel. Press **P+** or **P-** button to move up or down the page.
2. To watch a specific channel, highlight the “**OK**” box on Channel List menu using “**<**” or “**>**” button.

Filtering Options

Press **BLUE** button to view filtering options. You can filter channels by **Digital Aerial/Analog**, **TV/Radio**, **Free/CAS***, **A-Z** or **Sort** from channel list filter menu (*CAS=encrypted channels).

Moving a Channel

1. Select the desired channel.
2. Select **Move** box in the channel list and press **OK** button.
3. **Edit Number** screen will be displayed. Enter the desired channel number by using the numeric buttons on the remote control.

Note: If there is a previously stored channel on that number, a warning screen will be displayed.

4. Select **Yes** if you want to move the channel and press **OK**.

Deleting a Channel

1. Select the channel that you want to delete and select **Delete** box.
2. Press **OK** button to continue. A warning screen will appear. Select **YES** to delete, select **No** to cancel. Press **OK** button to continue.

Renaming a Channel

1. Select the channel that you want to rename and select **Edit Name** box. Press **OK** button to continue.
2. Use navigation buttons to toggle between the current character, i.e., ‘b’ character becomes ‘a’ by “**v**” and ‘c’ by “**^**”.
3. When finished, press **OK** button to save. Press **MENU** to cancel.

Locking a Channel

1. Select the channel that you want to lock and select **Lock** option. Press **OK** button to continue.
2. You will be asked to enter parental control PIN. Default PIN is set as **0000**. Enter the PIN number.
3. The desired channel is locked (Lock symbol is displayed next to the selected channel) or unlocked.

Sorting Channel List

You can select broadcasts to be listed in the channel list. To display specific types of broadcast, you should use Active channel list setting.

Select Active channel list from the Channel list menu by using “**^**” or “**v**” button. Press **OK** button to continue.



You can select a broadcast type option from the list by using “**^**” or “**v**” and **OK** buttons.

Basic Features

DVD Mode Disc Playback

1. When TV set is turned on, first switch to **DVD** source by using the **SOURCE** button on the remote control. Switch on the TV and insert a disc to the loader (fig.1).

2. The disc will be automatically loaded and play commences if the disc does not have any menus recorded on it. A menu may appear on the TV screen after a few moments or the film may start immediately after the introduction. This behaviour depends on the disc content and may change.

 **NOTE:** Step 3 and 4 is available only when a menu is recorded on the disc.

3. Press “↖” or “↘” or “←” or “→” or the numeric button (s) to select the preferred title.

4. Press OK.

Play of the selected items now starts. The played item may be a motion picture, a still picture or another submenu depending on the disc.

 **NOTE:**

If an action corresponding to a button is prohibited the “⊘” symbol appears.

No sound will be heard during Rapid advance or Rapid reverse.

No sound will be heard during Slow motion play.

Reverse slow motion play is not available.

In some cases, the subtitle language is not changed immediately to the selected one.

When the preferred language is not selected even after pressing the button several times, it means that the language is not available on the disc.

When the player is restarted or the disc is changed, the subtitle selection is automatically changed back to the initial settings.

If a language is selected, not supported by the disc, the subtitle language will automatically be set to the disc's priority language.

Usually a circulation will happen while switching to another language, that is you can cancel the subtitle by pressing this button a number of times until “Subtitle Off” appears on the screen.

When the power is turned on or the disc is removed, the language heard is the one selected at the initial settings. If this language is not recorded on the disc, only the available language on the disc will be heard.

Some DVDs may not contain root and/or title menus.

Reverse stepping is not available.

If you attempt to enter a number greater than the total time of the current title, the time search box disappears and “Input Invalid” message appears on up-left corner of screen.

Slide Show is disabled when the ZOOM mode is on.

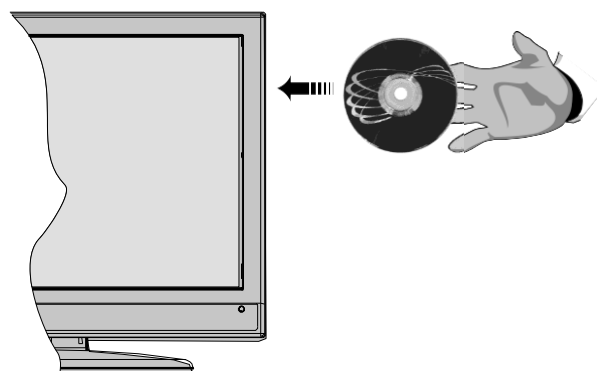

fig.1

Environmental Information

This television is designed to consume less energy to save environment.

You not only help to save the environment but also you can save money by reducing electricity bills thanks to the energy efficiency feature of this TV. To reduce energy consumption, you should take the following steps:

You can use Power Save Mode setting, located in the Feature menu. If you set Power Save Mode as On, the TV will switch to energy-saving mode and luminance level of TV set will be decreased to optimum level. Note that some picture settings will be unavailable to be changed when the TV is in Power Save Mode.



When the TV is not in use, please switch off or disconnect the TV from the mains plug. This will also reduce energy consumption.

Disconnect power when going away for longer time.

Note that annually, using the TV set in Power Save Mode has more power efficiency than disconnecting the TV from the mains plug instead of keeping stand-by mode. Therefore it is highly recommended to activate Power Save Mode setting to reduce your annual power consumption. And also it is recommended to disconnect the TV from the mains plug to save energy more when you do not use.

Please helps us to save environment by following these steps.

Repair Information

Please refer all servicing to qualified personnel. Only qualified personnel must repair the TV. Please contact your local dealer, where you have purchased this TV for further information.

Language Settings

You can operate the TV's language settings using this menu.

Press **"MENU"** button and select the Settings icon by using "**↶**" or "**↷**" button. Press **OK** button to view Settings menu. Use "**↶**" or "**↷**" button to highlight **Language** and press **OK** to continue:

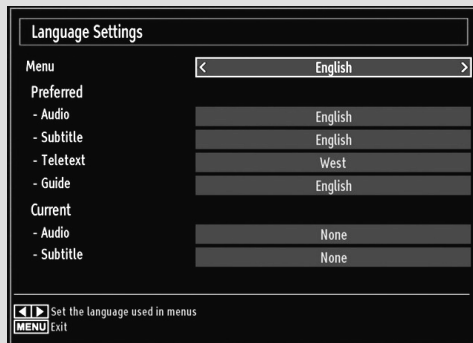

Use "**↶**" or "**↷**" button to set an item. Settings are stored automatically.

Menu: displays the system language.

Preferred

These settings will be used if available. Otherwise the current settings will be used.

Audio: Sets the preferred audio language.

Subtitle: Sets the subtitle language. Selected language will be seen in subtitles.

Teletext: Sets teletext language.

Guide: Sets the preferred Guide language.

Current (*)

() These settings can be changed if only the broadcaster supports. Otherwise, settings will not be available to be changed.*

Audio: Changes the audio language for the current channel.

Subtitle: Sets the subtitle language for the current channel.

 **NOTE:** If the Country option is set to Denmark, Sweden, Norway or Finland, the Language Settings menu will function as described below:

Language Settings

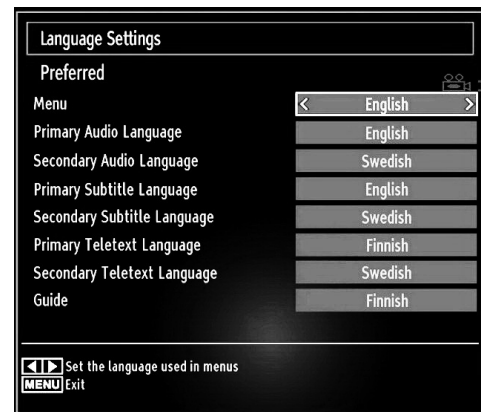

In the configuration menu, highlight the Language Settings item by pressing "**↶**" or "**↷**" buttons. Press **OK** and Language Settings submenu will be displayed on the screen:

Use "**↶**" or "**↷**" buttons to highlight the menu item that will be adjusted and then press "**↶**" or "**↷**" button to set.

 **NOTE:**

System Language determines the on-screen menu language.

Audio Language is used for selecting the soundtrack of a channels.

Primary settings are the first priority when multiple choices are available on a broadcast. Secondary settings are the alternatives when the first options are not available.

Other Functions and Features

Favourite Mode

You can create a list of favourite programmes using the favourites feature. In such a case, only the favourite channels are navigated.

1. Press "**MENU**" button to view main menu.
2. Select Channel List item by using "<" or ">" button.
3. Press "**OK**" to view menu contents.
4. Use "▲" or "▼" and "**OK**" buttons to select "Favourites".



5. Select a channel by using "▲" or "▼" button.
6. Press "**OK**" button to add selected channel to favourites list. Press "**OK**" button again to remove.

Button Functions

OK: Add/remove a station.

YELLOW: Tag/untag a channel.

GREEN: Tag/untag all channels.

BLUE: Displays filtering options.

Conditional Access

If you have inserted a conditional access module and viewing card to your TV, you can use Conditional Access menu. Note that these menu settings may change depending on the service provider.

1. Press "**MENU**" button and select the "Settings" icon by using "<" or ">" button.
2. Press "**OK**" button to view Settings menu.
3. Use "▲" or "▼" button to highlight **Conditional Access** and press "**OK**" to view menu items.

Setting Sleep Timer

This setting is used for setting the TV to turn off after a certain time.

1. Press "**MENU**" button and select the "Settings" icon by using "<" or ">" button.
2. Press "**OK**" button to view Timers menu.
3. Highlight Sleep Timer by using "▲" or "▼" button.

4. Use "<" or ">" button to set. The timer can be programmed between **Off** and **2.00** hours (120 minutes) in steps of 30 minutes.

Setting Programme Timers

You can set programme timers for a particular programme using this feature.

1. While in Timers menu, press "▼" button to activate timers functions.
2. Programme timer function buttons will be displayed on the screen.
3. Press **YELLOW** button on the remote control to add a timer. Timer options and definitions are as the following:

Network Type: This feature is unavailable to be set.

Timer Type: This feature is unavailable to be set.

Channel: Changes channel by using "<" or ">" button.

Record Type: This item is unavailable to be set.

Date: Enter a date using the numeric buttons.

Start: Enter a starting time using the numeric buttons.

End: Enter an ending time using the numeric buttons.

Duration: Displays duration between the starting and ending time.

Repeat: Sets a timer to be repeated as Once, Daily or Weekly. Use "<" or ">" buttons to select an option.

Change/Delete: Sets the change/delete permission.

Playback: Sets the playback permission and parental settings.

4. Press **GREEN** button to save the timer. Press **RED** button to cancel.

Editing a Timer

1. Select the timer you want to edit by pressing "▲" or "▼" button.
2. Press "**GREEN**" button. Edit Timer menu screen will be displayed.
3. When finished with editing, press "**GREEN**" button to save. You can press "**MENU**" button to cancel.

Deleting a Timer

1. Select the timer you want to delete by pressing "▲" or "▼" button.
2. Press **RED** button.
3. Select **YES** by using "Y" or "N" buttons to delete the timer. Select **NO** to cancel.

Basic Features

Picture Controls

Configuring Picture Settings

You can use different picture settings in detail.

Press “MENU” button and select the Picture icon by using “<” or “>” button. Press OK button to view Picture Settings menu.

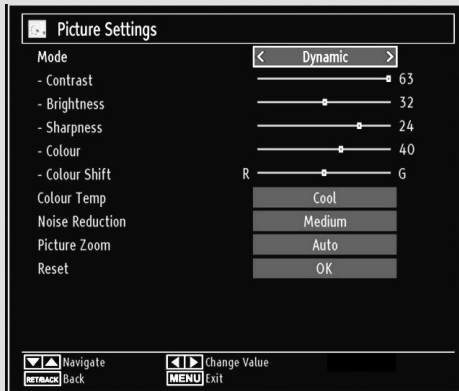

Operating Picture Settings Menu Items

Press “^” or “v” button to highlight a menu item.

Use “<” or “>” button to set an item.

Press “MENU” button to exit.

Picture Settings Menu Items

Mode: For your viewing requirements, you can set the related mode option. Picture mode can be set to one of these options: **Cinema, Game, Dynamic** and **Natural**.

Contrast: Sets the lightness and darkness values of the screen.

Brightness: Sets the brightness value for the screen.

Sharpness: Sets the sharpness value for the objects displayed on the screen.

Colour: Sets the colour value, adjusting the colors.

Colour Shift: Adjust the desired colour tone.

Colour Temp: Sets the desired colour tone.

Setting **Cool** option gives white colours a slight blue stress.

For normal colours, select **Normal** option.

Setting **Warm** option gives white colours a slight red stress.

Noise Reduction: If the broadcast signal is weak and the picture is noisy, use **Noise Reduction** setting to reduce the noise amount. Noise Reduction can be set to one of these options: **Low, Medium, High** or **Off**.

Game Mode: When Game Mode is set to On, specific game mode settings, which are optimized for better video quality, will be loaded.

NOTE: When Game Mode is on, some items in the Picture Settings menu will be unavailable to be set.

Picture Zoom: Sets the picture size to **Auto, 16:9, Subtitle, 14:9, 14:9 Zoom, 4:3, Panoramic** or **Cinema**.

Reset: Resets the picture settings to factory default settings.

While in VGA (PC) mode, some items in Picture menu will be unavailable. Instead, VGA mode settings will be added to the Picture Settings while in PC mode.

PC Picture Settings Operation

For adjusting PC picture items, do the following:

Press “<” or “>” button to select Picture icon. Picture menu appears on the screen.

Contrast, Brightness, Colour, Colour Temp and Picture Zoom, Reset settings in this menu are identical to settings defined in TV picture settings menu. **Sound, Settings and Source** settings are identical to the settings explained in the main menu system.

PC Position: Select this to display PC position menu items.

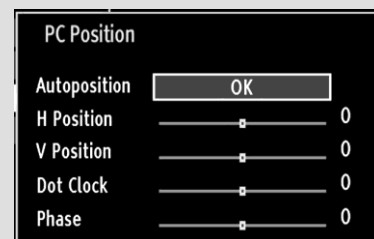

Autoposition: Automatically optimizes the display. Press OK to optimize.

H Position: This item shifts the image horizontally to right hand side or left hand side of the screen.

V Position: This item shifts the image vertically towards the top or bottom of the screen.

Dot Clock: Dot Clock adjustments correct the interference that appear as vertical banding in dot intensive presentations like spreadsheets or paragraphs or text in smaller fonts.

Phase: Depending on the resolution and scan frequency that you input to the TV set, you may see a hazy or noisy picture on the screen. In such a case you can use this item to get a clear picture by trial and error method.

Basic Features

Sound and Source Settings

Configuring Sound Settings

Sound settings can be configured according to your personal preferences.

Press “**MENU**” button and select the first icon by using “**<**” or “**>**” button. Press **OK** button to view Sound Settings menu.

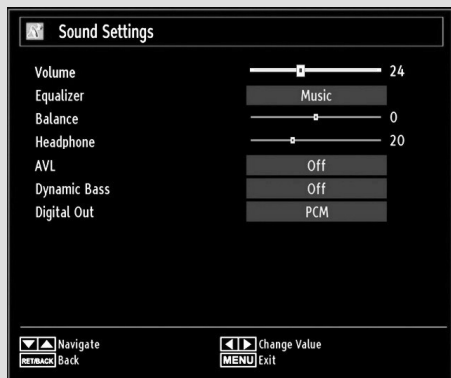

Operating Sound Settings Menu Items

Press “**^**” or “**v**” button to highlight a menu item.

Use “**<**” or “**>**” button to set an item.

Press “**MENU**” button to exit.

Sound Settings Menu Items

Volume: Adjusts volume level.

Equalizer: Press **OK** button to view equalizer sub-menu.

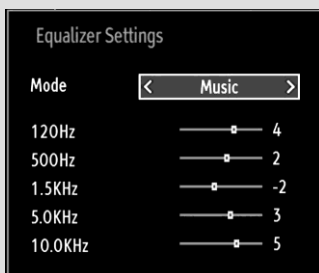

In the equalizer menu, the preset can be changed to **Music**, **Movie**, **Speech**, **Flat**, **Classic** and **User**. Press the “**MENU**” button to return to the previous menu.

NOTE: Equalizer menu settings can be changed manually only when the **Equalizer Mode** is in **User**.

Balance: This setting is used for emphasizing left or right speaker balance.

Headphone: Sets headphone volume.

AVL: Automatic Volume Limiting (AVL) function sets the sound to obtain fixed output level between programmes (For instance, volume level of advertisements tend to be louder than programmes).

Dynamic Bass: Dynamic Bass is used to increase bass effect of the TV set.

Surround Mode: Surround mode can be change as On or Off.

Digital Out: Sets digital out audio type.

Configuring Source Settings

You can enables or disable selected source options. The TV will not switch to the disabled source options when “**SOURCE**” button is pressed.

Press “**MENU**” button and select Settings icon by using “**<**” or “**>**” button. Press **OK** button to view **Settings** menu. Select Source and press **OK** button.

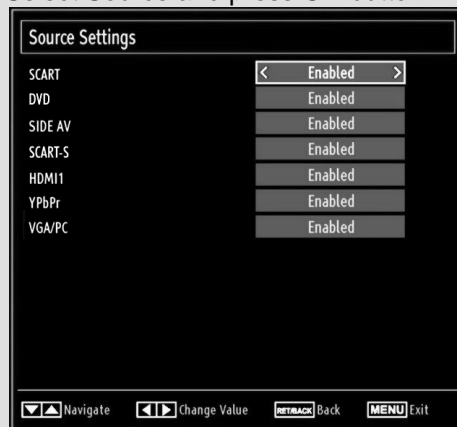

Select **Sources** in the Settings menu and press **OK** button.

Press “**<**” or “**>**” buttons to select a source.

Use “**<**” or “**>**” button to enable or disable the selected source. Changes are automatically stored.

Basic Features

Other Controls

To view general configuration preferences, select **Other Settings** in the Settings menu and press **OK** button.

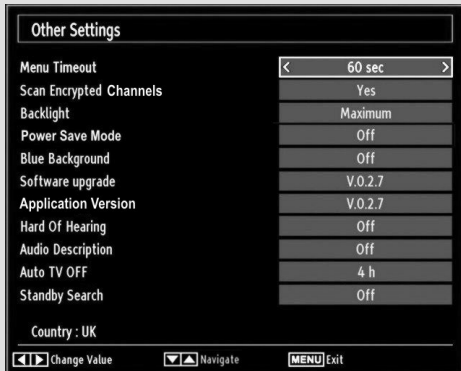

Operation

Press “ \wedge ” or “ \vee ” buttons to select an item.

Use “ \langle ” or “ \rangle ” button to set an option.

Press **OK** button to view a sub-menu.

Other Settings Menu Items

Menu Timeout: Changes timeout duration for menu screens.

Scan Encrypted Channels: When this setting is set as **YES**, search process will locate the encrypted channels as well. If it is set as **NO**, encrypted channels will not be located in automatic search or manual search.

Backlight: This setting controls the backlight level by changing the screen luminance and it can be set to Maximum, Minimum, Medium and Eco Mode (optional).

Power Save Mode: Use “ \wedge ” or “ \vee ” button to select Power Save Mode. Press “ \langle ” or “ \rangle ” button to set Power Save Mode as On or Off. See the section, “Environmental Information” in this manual for further information on Power Save Mode.

NOTE: Backlight function will be invisible if Power Save Mode is set to on.

Blue Background: Activates or deactivates blue background system when the signal is weak or absent.

Software Upgrade: To ensure that your TV always has the most update information, you can use this setting. In order for the proper operation, please ensure that the TV is set to standby mode.

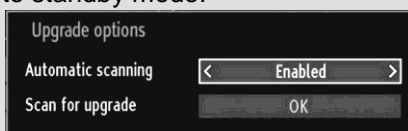

You can enable or disable automatic upgrade by setting **Automatic Scanning** option.

You can manually search for new software by selecting **Scan for upgrade**.

Application version: Displays the current application version.

Hard of Hearing: If the broadcaster enables any special signal concerning the audio, you can set this setting as On to receive such signals.

Audio Description: Audio description refers to an additional narration track for blind and visually impaired viewers of visual media, including television and movies. The description narrator talks through the presentation, describing what is happening on the screen during the natural pauses in the audio (and sometimes during dialogue, if deemed necessary). You can use this feature, only if the broadcaster supports that additional narration track.

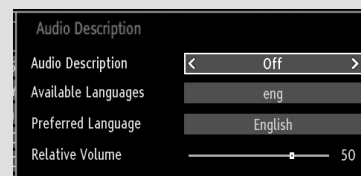

Auto TV Off: You can set the timeout value of auto off feature. After the timeout value is reached and the TV is not operated for selected time, the TV will go off.

Broadcast Type (optional): When you set the desired broadcast type by using “ \langle ” or “ \rangle ” button, the TV will display the related channel list. If the related source has does not include any stored channels, “No channels for this type have been found.” message will be displayed on the screen.

Standby Search (optional): Use “ \wedge ” or “ \vee ” button to select Standby Search and then press “ \langle ” or “ \rangle ” button to set this setting as On or Off. If you change Standby Search to Off, this function will be unavailable. To use Standby search please make sure that you select Standby Search as On.

Advanced Features

Media Browser

Only available when a USB device is plugged into the TV.

Starting Media Browser

1. Press **MENU** button on the remote control and select "**Media Browser**" pressing "**<**" or "**>**" button.
2. Press **OK** button to continue.
3. Use the "**^**" or "**v**" button to select a device and press OK. Media Browser menu contents (depending on the contents of your USB drive) will be displayed. You can play music, picture and video files from the connected USB memory stick.



Media Browser Configuration

Select Settings icon from the main media browser page to view the current preferences.



You can set your Media Browser preferences by using the Settings dialogue.

Operation

- Press "**^**" or "**v**" button to highlight an item.
Use "**<**" or "**>**" button to configure an item.

View Style

Sets default browsing mode. Sets default browsing mode as folder or flat. Select "Directory" to display files in a folder or "Normal" to view files directly. If you select the view style "Directory" the menu point "All" will appear in the media browser (See the section: Media playback using media browser). The option "All" gives you an overview of the directories images, music, videos.

Slide Show Interval

Sets slide show interval time.

Show Subtitle

Sets subtitle enabling preference.

Subtitle Language

Sets supported subtitle language.

Subtitle Position

Sets subtitle position as up or down.

Subtitle Font Size

Sets subtitle font size (max. 54pt).

Loop / Shuffle during Playback

Press **BLUE** button once to disable Loop.

Press again to disable both Loop and Shuffle.

Press once more to enable only Loop.

Press again to enable all and again to deactivate all.

By the change of the symbols you can see which feature is enabled.

Advanced Features

Media Browser - continued

Viewing Videos via USB



1. Select **Videos** from the **Media Browser** screen and press **OK** button.
2. All video files will be filtered and listed.
3. Use “▼” or “▲” button to select a video file and press **OK** button to play a video.

Follow the information on the operations bar for using other commands.

Video Playback Screen

The following screen will be displayed while playing a video file.

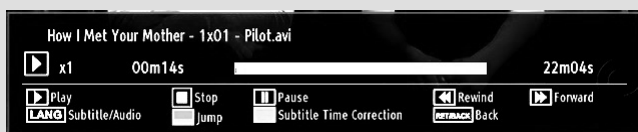

Subtitle Time Correction

Press **YELLOW** button during the video playback for activating **Subtitle Time Correction** screen.

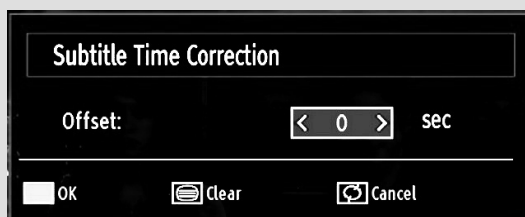

1. Enter an offset value using “◀” or “▶” button.
2. Press **YELLOW** button to confirm or press **RETURN** button to switch back to previous menu.

Viewing Photos via USB



1. Select **Photos** from the **Media Browser** screen and press **OK** button.
2. All photo files will be filtered and listed.
3. Use “▼” or “▲” button to select a photo file and press **OK** button to play a video.

Follow the information on the operations bar for using other commands.

Displaying Photos in Slideshow Mode

1. Press **GREEN** button when viewing photo files to activate slideshow mode.



2. Press **RETURN** to go back to Photos screen.

Follow the information on the operations bar for using other commands.

Playing Music via USB



1. Select **Music** from the **Media Browser** screen and press **OK** button.
2. All music files will be filtered and listed.
3. Use “▼” or “▲” button to select a music file and press **OK** button to play.

Follow the information on the operations bar for using other commands.

Advanced Features

Setting the channels

Accessing Installation Menu

1. Press **"MENU"** button on the remote control and select **Installation** by using "**<**" or "**>**" button.
2. Press **"OK"** button and the **Installation** screen will be displayed.



Automatic Channel Scan (Retune)

1. In the Installation menu, select "Automatic Channel Scan (Retune)" by using "**^**" or "**v**" button and press **OK** button.
2. Options will be displayed. You can select options by using "**^**" or "**v**" and **OK** buttons.

Menu Operations

Digital Aerial: Searches and stores aerial DVB stations.

Analogue: Searches and stores analogue stations.

Digital & Analogue: Searches and stores both analogue and aerial DVB stations.

3. Whenever you select an automatic search type and press **OK** button, a confirmation screen will appear on the screen. To start installation process, select **Yes**, to cancel select **No** by using "**<**" or "**>**" and "**OK**" button.

4. After auto channel scan type is set and selected and confirmed, installation process will start and progress bar will move along.

If desired, press **"MENU"** button to cancel process. In such a case, located channels are not stored.

Manual Channel Scan

1. In the Installation menu, select "Manual Channel Scan" by using "**^**" or "**v**" button and press **OK** button.
2. Manual Scan options screen will be displayed.

Select the desired "Search Type" using "**<**" or "**>**" button. Manual search options will change accordingly.

3. Enter the multiplex (for digital manual search) or frequency number (for analogue manual search) using the numeric buttons and press **OK** button to start search.

Analogue Fine Tune

1. Select "Analogue Fine Tune" from the Installation menu by using "**v**" or "**^**" and **OK** buttons. Analogue fine tune screen will be displayed.

 **NOTE:** Analogue Fine Tune feature will not be available if there are no analogue channels, digital channels and external sources stored.

2. Press **OK** button to proceed. Use "**<**" or "**>**" button to set Fine Tune. When finished, press **OK** button again.

First Time Installation

Deletes all stored channels and settings, resets TV to factory settings and starts first time installation.

1. Select **First Time Installation** option and press **OK** button if you would like to reset the TV.
2. A warning screen will be displayed. Select **YES** and press **OK** to continue. All prestored channels and settings will be deleted in such a case.
3. The TV will reset after a short time and language selection menu will be displayed.
4. Follow the steps in the **Initial set up** section.

Clear Service List

(* *This setting is visible only when the Country option is set to Denmark, Sweden, Norway or Finland.*)

1. Use this setting to clear channels stored. Press "**^**" or "**v**" button to select Clear Service List and then press **OK**.
2. An OSD message will be displayed on the screen. Press **OK** to cancel or select **Yes** to delete all of the stored channels.

Advanced Features

Parental Control

To prohibit viewing of certain programmes, channels and menus can be locked by using the parental control system. This function enables or disables the menu protection system and allows the PIN code to be changed.

1. Press “**MENU**” button and select the Settings icon by using “**<**” or “**>**” button.
2. Press OK button to view Settings menu. Use “**^**” or “**v**” button to highlight Parental and press “**OK**” to continue:



3. To display parental lock menu options, PIN number must be entered. Factory default PIN number is **0000**. After coding the correct PIN number, parental settings menu will be displayed:



Parental Settings Menu Operation & Items

- Select an item by using “**^**” or “**v**” button. Use “**<**” or “**>**” button to set an item.
- Press **OK** button to view more options.

Menu Lock: Menu lock setting enables or disables the menu access. You can disable access to the installation menu or the whole menu system.

Maturity Lock (not available for the UK): When set, this option gets the maturity information from the broadcast and if this maturity level is disabled, disables access to the broadcast.

Child Lock (optional): When Child Lock is set, the TV can only be controlled by the remote control. In this case the control panel buttons will not work, except for the Standby Off/On button. When Child Lock is activated you are able to switch the TV into Standby mode with the Standby Off/On button. To switch the TV on again, you need the remote control. Hence, if one of those buttons is pressed, **Child Lock Is On** will be displayed on the screen when the menu screen is not visible.

Set PIN: Defines a new PIN number. Use numeric buttons to enter a new pin number. You will need to code your new pin a second time for verification purposes.

 **IMPORTANT:** The factory default pin number is **0000**, if you change the pin number make sure you write it down and keep it safe.

Advanced Features

DVD Mode Configuration

1. While in DVD source, press DISPLAY button to access DVD Setup menu. This is only possible if there is no playback.



2. This menu is operated using “<” or “>” and “^” or “v” buttons.

TV Type

TV Type is only available as ‘PAL’. The TV set also supports NTSC signal; however, the signal will be converted to PAL when it appears on the screen.

Language Setup

This menu is used for setting language preferences in DVD mode. Language menu contents are detailed below:

OSD LANG

You can select the default OSD language of the player menus

AUDIO

You can select the default audio language if supported by the DVD disc.

DISC MENU

You can select the DVD’s disc menu language among these languages. Disc menu appears in the selected language, if supported by the DVD disc.

SUBTITLE

You can select the default subtitle language if supported by the DVD disc.

Preferences: These are the DVD mode preferences. Menu contents are detailed below:

DEFAULT

If you choose RESET and press SELECT, the factory-presets are loaded. Parental level and parental password does not change.

DOWNMIX

This mode can be selected when the digital audio output of the TV is used.

SURROUND

Surround sound output.

STEREO

Two channels stereo.

PARENTAL

Playing some DVDs can be limited depending on the age of users. The “Parental Control” function allows playback limitation level to be set by the parent. Parental

Level can be adjusted to one of the eight levels. Level “8 ADULT” adjustment let you watch all of the DVD titles ignoring the DVD disc’s parental level. You can watch the DVD discs, which has the same or lower parental level than the player’s level only. Menu contents are detailed below:

PASSWORD

Using this item you can change the current password. To change the password you will be prompted to enter your old password. After you have entered your old password, you can now enter the new 4-digit password. You can use C key to delete the incorrect entry.

 **NOTE:** Factory preset of the password is “0000”. You have to enter XXXX digital password every time you want to change the parental level. If you forget your password please contact technical service.

SPDIF OUTPUT

You can set Spdif Output as PCM or RAW. If you select PCM from SPDIF Output in DVD menu and play DVD with Dolby audio, you can get audio output with two channels via the speakers and the SPDIF Out. If you select RAW from SPDIF Output in DVD menu and play DVD with Dolby audio, speakers will be muted and you can get 5+1 Dolby audio via the SPDIF Out.

Other Information

Teletext

Analogue Teletext

Teletext system transmits information such as news, sports and weather on your TV. Note that is the signal degrades, for example in poor/adverse weather conditions, some text errors may occur or the teletext mode may be aborted.

Analogue Teletext

Teletext function buttons are listed below:

“” **Teletext / Mix** : Activates teletext mode when pressed once. Press again to place the teletext screen over the programme (mix). Pressing again will quit the teletext mode.

“**RETURN**” **Index**: Selects the teletext index page.

“**INFO**” **Reveal**: Shows hidden information (e.g. solutions of games).

“**OK**” **Hold**: Holds a text page when convenient. Press again to resume.

“ < ” or “ > ” **Subcode Pages** : Selects subcode pages if available when the teletext is activated.

P+ / P- and **numbers (0-9)**: Press to select a page.

Note: Most TV stations use code 100 for their index pages.

Coloured Buttons

(RED/GREEN/YELLOW/BLUE)

Your TV supports both **FASTTEXT** and **TOP text** systems. When these systems are available, the pages are divided into groups or topics. When **FASTTEXT** system is available, sections in a teletext page will become colour-coded and can be selected by pressing the coloured buttons. Press a coloured button that corresponds to with your needs. The coloured writings will appear, showing you which coloured buttons to use when **TOP text** transmission is present. Pressing “ ^ ” or “ v ” commands will request the next or previous page respectively.

Digital Teletext (for the UK only)

1. Press the “” button. The digital teletext information appears on screen.

2. Operate using the coloured buttons, cursor buttons and **OK** button.

The operation method may differ depending on the contents of the digital teletext.

3. Follow the instructions displayed on digital teletext screen.

When “Press **SELECT** button” or similar message appears on the screen, press **OK** button.

When the “” button is pressed, the TV returns to television broadcasting.

When you press the “” button again, the digital teletext screen will be displayed.

Other Information

Specifications

TV Broadcasting	PAL/SECAM B/G D/K K' I/I' L/L'
Receiving Channels	VHF (BAND I/III) - UHF (BAND U) - HYPERBAND
Number of Preset Channels	1000
Channel Indicator	On Screen Display
RF Aerial Input	75 Ohm (unbalanced)
Operating Voltage	220-240V AC, 50Hz.
Audio	German+Nicam Stereo
Audio Output Power (W_{RMS}) (10% THD)	2 x 2,5
Power Consumption	50 W
Weight	5,90
TV Dimensions DxLxH (with foot)	149 x 576 x 403
TV Dimensions DxLxH (without foot)	35 x 576 x 368
VESA	75 x 75 mm / M4
Display	16:9 display, 61 cm / 24" Screen Size 1366x768 max. resolution
DVD Mode Specifications	
Types of Discs Supported	DVD: SS/SL 4.7" (DVD-5), SS/DL 4.7" (DVD-9) , DS/SL 4.7" (DVD-10), DS/DL 4.7" (DVD-18) CD-DA, CD-R, CD-RW, Photo-CD
Video Type	MPEG-2 Video Standard Decoding (MPEG-1 supported), Full-Screen Video Display of 720 x 576 (PAL) & 720 x 480 (NTSC) pixels, 50 and 60 Hz frame refresh rates (PAL & NTSC), Digital bit-stream processing rate up to 108Mbits/sec
Audio Type	MPEG 1/2, Layer 1/23 (MP3), AC3
Picture Type	Baseline JPEG, progressive JPEG
Audio Output	Analog Outputs: 24 bit /48, 44.1kHz down-sampling DAC
Digital Reception (DVB-T)	
MHEG-5 ENGINE compliant with ISO/IEC 13522-5 UK engine Profile 1 - for UK	
Object carousel support compliant with ISO/IEC 135818-6 and UK DTT profile - for UK	
Frequency range: 474-850 MHz for UK models	
170-862 MHz for EU models	
Transmission standard: DVB-T. MPEG-2, MPEG-4	
Demodulation: COFDM with 2K/8K FFT mode	
FEC: all DVB models	
Video: MP@ML, PAL, 4:3/16:9	
Audio: MPEG Layer I&II 32/44.148kHz.	
We apologise for any inconvenience caused by any minor inconsistencies in these instructions, which may occur as a result of product improvements and development.	

Other Information

Plug replacement - UK and Ireland only

Should you need to replace the plug; the wires in the power cable are coloured in the following way:

Blue – Neutral 'N'

Brown – Live 'L'

Green & Yellow – Earth 'E'

As the colours of the wires in the power cable may not correspond with the coloured markings identifying the terminals in your plug, and proceed as follows:

The green & yellow wire must be connected to the terminal in the plug that is marked with the letter E or by the earth symbol.

The blue wire must be connected to the terminal that is marked with the letter N.

The brown wire must be connected to the terminal that is marked with the letter L.

If the power lead is damaged, it must be replaced by a qualified electrician.

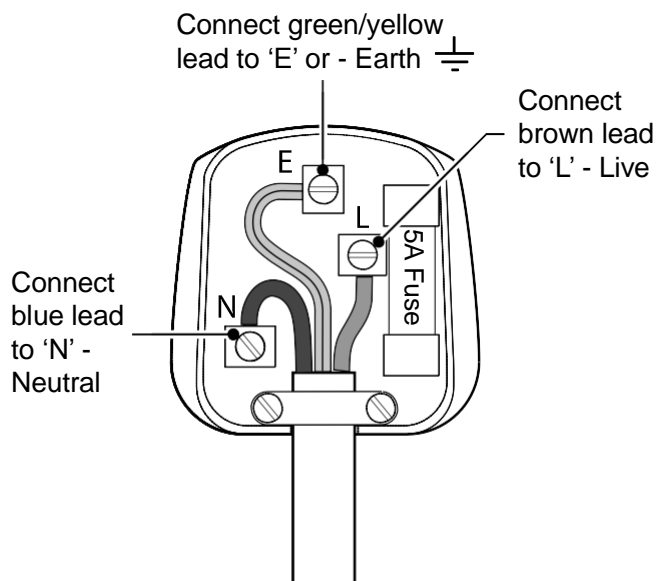

Technical experts are available 7 days a week

- **Simple help and advice on setting up your digital equipment (image).**
- **Guidance on connecting other devices to your television such as a DVD player, Sky, home cinema system or a games console.**
- **Order spare parts, including that lost remote control.**
- **Any other technical issues you may need assistance with.**

Call us today: 0345 604 0105

Local call rates applies*

Lines open 9am-8pm Monday to Saturday and 10am-4pm Sunday.

*Calls to Argos enquiry lines may attract a charge and set up fee from residential lines depending on your call plan/tariff. Mobile and other providers costs may vary, see www.bt.com/pricing for details.

For Security and training purposes, telephone calls to and from customer service centres maybe recorded and monitored. Calls from Republic of Ireland will attract international call charges.

Product Support

Trouble shooting

Image persistence - ghosting

Please note that ghosting may occur while displaying a persistent image (still or paused image). LCD TVs' image persistence may disappear after a short time. Try turning off the TV for a while. To avoid this, do not leave the screen in still picture mode for extended periods.

No power

If your TV has no power, please check the power cord plug is connect to the mains power socket.

Poor picture

1. Have you selected the correct TV system?
2. Is your TV or house aerial located too close to a non-earthed audio equipment or neon lights, etc.?
3. Mountains or high buildings can cause double pictures or ghost images. Sometimes you can improve the picture quality by changing the direction of the aerial. Is the picture or teletext unrecognisable?
4. Check if you have entered the correct frequency.
5. Please retune the channels.
6. The picture quality may degrade when two devices are connected to the TV at the same time. In such a case, disconnect one of the devices.

No picture

1. No Picture means that your TV is not receiving a transmission. Have you selected the correct button on the remote control? Try once more. Also make sure the correct input source has been selected.
2. Is the aerial connected properly?
3. Are the plugs connected tightly to the aerial socket?
4. Is the aerial cable damaged?
5. Are suitable plugs used to connect the aerial?
6. If you are in doubt, consult your dealer.

No sound

1. Has the TV been set to mute? To cancel mute, press the "M" button, or increase the volume level.
2. Sound is coming from only one speaker. Is the balance set to one extreme? See Sound Menu section.
3. If there is no digital amplifier, the option PCM in the SPDIF OUTPUT menu should be activated. Otherwise there will be no sound output from the speakers.

Remote control - does not operate

Your TV no longer responds to the remote control. The batteries may be exhausted, if so you can still use the control buttons on the left side of the TV. (* Is only possible if they are not blocked by parental control.)

Input sources - can not be selected

1. If you cannot select an input source, it is possible that no device is connected.

2. Check the AV cables and connections if you have tried to connect a device.

The DVD picture quality is poor

1. Make sure the DVD disc surface is not damaged (no scratches, fingerprints etc.).
2. Clean the DVD disc and try again. *See instructions in "Cleaning Discs" to clean your disc properly page 00.*
3. Ensure that the DVD disc is in the loader with the label facing you when looking at the TV screen.
4. A damp DVD disc or condensation may effect the equipment. Wait for 1 to 2 hours in Stand-by mode to dry the equipment.

The Disc does not play

1. No disc in the machine - *Place a disc into the loader.*
2. Disc is incorrectly loaded - *Ensure that the DVD disc is in the loader with the label facing you when looking at the TV screen.*
3. Wrong type of disc. The DVD player cannot play CD-ROMS etc.
4. The region code of the DVD disc must match the player.

Ensure that the DVD disc is in the loader with the label facing to the front.

Wrong type of disc. The machine cannot play CD-ROMS with PC-Data.

Wrong OSD language

1. Select the language in the setup menu.
2. The language for the sound or subtitles on a DVD disc cannot be changed.
3. Multilingual sound and/or subtitles are not recorded on the DVD disc.
4. Try to change the sound or subtitles using DVD's title menu. Some DVD's do not allow the user to change these settings without using the disc's menu.

Angle, Zoom etc. functions do not work

1. These functions are not available on the DVD.
2. Angle can only be changed when the angle symbol is displayed.

If nothing works..

If you have tried the above solutions and none seem to work, try switching your TV-DVD off and on again. If this does not work, contact your supplier or TV-DVD repair technician. Never attempt to repair a defective TV-DVD yourself.

Product Support

DVD Mode Supported file formats

Media	File Extension	Format		Supported (Maximum resolution/Bit rate etc.)
		Video	Audio	
Movie	.mpg/.dat/.vob	MPEG1	MPEG Layer 1/2/3	
		MPEG2	MPEG2	
	.avi (optional)	XviD/3ivx	PCM/MP3	XviD Version up to:1.1.2
		MPEG4	PCM/MP3	
		MS ISO MPEG4	PCM/MP3	Support SP and ASP
Music	-	-	PCM	Sample Rate: 8K ~ 48KHz
	.mp3	-	MPEG 1/2 Layer 1/2/3 (MP3)	Sample Rate: 8K ~ 48KHz, Bit Rate: 64K ~ 320Kbps
Photo	.jpg	Baseline JPEG		W x H = 8902 x 8902 up to 77 Mega-pixel Support format: 444/ 440/ 422/ 420/ Grayscale
		Progressive JPEG		Up to 4 Mega-pixel Support format: 444/ 440/ 422/ 420/ Grayscale
External Subtitles	.srt			Support Text File Format, but do not support Picture File Format
	.smi			
	.sub			
	.ssa			
	.ass			

Disposal information

Instructions for waste disposal:

Packaging and packaging aids are recyclable and should principally be recycled. Packaging materials, such as foil bag, must be kept away from children.

The cold cathode fluorescent lamp in LCD PANEL contains a small amount of mercury; please follow the local laws or regulations for disposal.

Information for Users on Disposal of old Equipment and Batteries (European Union only)

These symbols indicate that equipment with these symbols should not be disposed of as general household waste. If you want to dispose of the product or battery, please consider the collection systems or facilities for appropriate recycling.

Notice: The sign Pb below the symbol for batteries indicates that this battery contains lead.

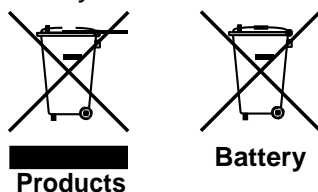

Information for Users in European Union Countries





This symbol on the product or on its packaging means that your electrical and electronic device should be disposed of at the end of its service life separately from your household wastes. There are separate collection systems for recycling in EU.

For more information, please contact the local authority or the dealer where you purchased the product.



Product Support

Compatible disc types

Disc Types (Logos)	Recording Types	Disc Size	Max. Playing Time	Characteristics
	Audio + Video	12cm	Single sided; 240 min. Double sided; 480 min.	DVD contains excellent sound and video due to Dolby Digital and MPEG-2 System. Various screen and audio functions can be easily selected through the on screen menu.
	Audio	12cm	74 min.	An LP is recorded as an analogue signal with more distortion. CD is recorded as a digital signal with better audio quality, less distortion and less deterioration of audio quality over time.
	Audio (xxxx.mp3)	12cm	Depends on MP3 quality	MP3 is recorded as a digital signal with better audio quality, less distortion and less deterioration of audio quality over time.
	Video (still picture)	12cm	Depends on JPG quality	JPEG is recorded as a digital signal with better picture quality over time.

For proper operation, only 12 cm discs must be used.

Supported DVI Resolutions

When connecting devices to your TV's connectors by using DVI converter cables (not supplied), you can refer to the following resolution information.

	24Hz	25Hz	30Hz	50Hz	60Hz
480i					
480p					
576i					
576p					
720p					
1080i					
1080p					

Product Support

Supported File Formats for USB Mode

Media	File Extension	Format		Remarks
		Video	Audio	(Maximum resolution/Bit rate etc.)
Movie	.mpg, .mpeg	MPEG1, 2	MPEG Layer 1/2/3	MAX 1920x1080 @ 30P 20Mbit/sec
	.dat	MPEG1, 2	MPEG2	
	.vob	MPEG2		
	.mkv	H.264, MPEG1,2,4	EAC3 / AC3	
	.mp4	MPEG4, Xvid 1.00, Xvid 1.01, Xvid 1.02, Xvid 1.03, Xvid 1.10-beta1/2 H.264	PCM/MP3	MAX 1920x1080 @ 30P 20Mbit/sec
.avi	MPEG2, MPEG4	PCM/MP3		
	Xvid 1.00, Xvid 1.01, Xvid 1.02, Xvid 1.03, Xvid 1.10-beta1/2 H.264	PCM		
Music	.mp3	-	MPEG 1 Layer 1 / 2 (MP3)	32Kbps ~ 320Kbps(Bit rate) 32KHz ~ 48KHz(Sampling rate)
Photo	.jpg .jpeg	Baseline JPEG		max WxH = 15360x8640 4147200bytes
		Progressive JPEG		max WxH = 1024x768 6291456bytes
	.bmp	-		max WxH = 9600x6400 3840000bytes
Subtitle	.sub	-		-
	.srt	-		

AV and HDMI Signal Compatibility (Input Signal Types)

Source	Supported Signals		Available
EXT (SCART)	PAL 50/60		O
	NTSC 60		O
	RGB 50		O
	RGB 60		O
Side AV	PAL 50/60		O
	NTSC 60		O
YPbPr	480I	60Hz	O
	480P	60Hz	O
	576I	50Hz	O
	576P	50Hz	O
	720P	50Hz	O
	720P	60Hz	O
	1080I	50Hz	O
	1080I	60Hz	O
	1080P	50Hz	O
	1080P	60Hz	O
	480I	60Hz	O
	480P	60Hz	O
	576I	50Hz	O
	576P	50Hz	O
HDMI	720P	50Hz	O
	720P	60Hz	O
	1080I	50Hz	O
	1080I	60Hz	O
	1080P	50Hz	O
	1080P	24Hz	O

(X: Not Available, O: Available)

In some cases a signal on the LCD TV may not be displayed properly. The problem may be an inconsistency with standards from the source equipment (DVD, Set-top box, etc.). If you do experience such a problem please contact your dealer and also the manufacturer of the source equipment.

Definition of important terms - DVD

Angle

Recorded onto some DVD discs are scenes, which have been simultaneously shot from a number of different angles (the same scene is shot from the front, from the left side, from the right side, etc.) . With such discs, the **ANGLE** button can be used to view the scene from different angles.

Chapter Number

These numbers are recorded on DVD discs. A title is subdivided into many sections, each of which are numbered, and specific parts of video presentations can be searched quickly using these numbers.

DVD disc

This refers to a high-density optical disc on which high-quality pictures and sound have been recorded by means of digital signals. Incorporating a new video compression technology (MPEG II) and high-density recording technology. DVD discs enables aesthetically pleasing full-motion video to be recorded over long periods of time (for instance, a whole movie can be recorded). DVD discs have a structure consisting of two 0.6mm thin discs, which are adhered to each other. Since the thinner the disc, the higher the density at which the information can be recorded, a DVD disc has a greater capacity than a single 1.2mm thick disc. Since the two thin discs are adhered to each other, there is the potential to achieve double-sided play sometime in the future for even longer duration play.

Subtitles

These are lines of text appearing at the bottom of the screen, which translate or transcribe the dialogue. They are recorded on the DVD discs.

Time Number

This indicates the playtime, which has elapsed from the start of a disc or a title. It can be used to find a specific scene quickly. (Not all discs permit the time search feature to be used. Availability is determined by the disc's manufacturer.)

Title Number

These numbers are recorded on DVD discs. When a disc contains two or more movies, these movies are numbered as title 1, title 2, etc.

Track Number

These numbers are assigned to the tracks, which are recorded on Audio CDs. They enable specific tracks to be located quickly.

Dolby Digital

Many movie theatres are equipped with 5.1 channel surround systems. This same type of technology is available to you in your home. To enjoy full 5.1-channel surround, your DVD player must be connected to an external Dolby Digital decoder via the digital outputs (either coaxial or optical).

Dolby Pro Logic

This is Dolby Laboratories' technology to decode Dolby Surround encoded programs actively. Dolby Surround programs have four channels of audio (Left, Centre, Right and Surround) encoded into a standard 2-channel stereo signal. The rear channel is monaural.

LPCM

LPCM stands for Linear Pulse Code Modulation and is digital audio.

MPEG

Short for Moving Picture Experts Group. This is an international standard for compression of moving images. On some DVDs digital audio has been compressed and recorded in this format.

Product Support

Definition of important terms - TV

Aspect Ratio

This refers to the ratio of the width to the height of a picture.

AVL

Automatic volume limiter.

Brightness

This defines the overall light level of the entire image.

Contrast

This will adjust the range of optical density and tone of the complete picture.

Component Audio Inputs

Used for the standard analog audio for interconnection of components.

Component Video Inputs (Y/Pb/Pr)

This video signal consist of colour differences and a luminance signal.

DTV

Digital television broadcasts.

HDMI

High Definition Multimedia Interface. This connection provides high-quality, uncompressed digital video and audio, combining both audio and video signals via a single connection.

Multichannel audio

Means that the TV program is aired in several audio versions, for example, in two different languages. This is possible if on an analogue TV each of the two channels of the stereo tracks for left and right channels are occupied with one audio track in mono (single channel). In digital TV multiple audio streams can be broadcasted and selected on the receiver side

NTSC

United States' standard for scanning television signals that has been adopted by some other countries.

LCN

LCN is the Logical Channel Number system that organizes available broadcasts in accordance with a recognizable channel sequence.

OSD

On Screen Display. Information, like channel number and volume on the screen of a TV.

PAL

The European TV standard for scanning television signals.

Scart

A 21-pin audio/video connector found primarily on European televisions.

SECAM

The video format used in France and some other countries, similar to PAL.

Sharpness

A control that creates the effect of greater resolution by light to dark transitions.

System

Defines the broadcast type of the TV picture since these broadcast systems are not same for all countries.

VGA

VGA is a common standard graphics display system for PCs.

Product Support

Software Upgrade

Your TV is capable of finding and updating new software upgrades over broadcast channels.

For broadcast channels search, TV looks the available channels stored in your settings. So before software upgrade search, it is advised to auto search and update all available channels.

1) Software upgrade search via user interface

It is possible manually to check if there is a new software upgrade for your TV set.

Simply navigate on your main menu. Choose Settings and select Other Settings menu. In Other Settings menu navigate on to the Software Upgrade item and press OK button to open Upgrade Options menu.

In Upgrade Options menu select Scan for upgrade and press OK button.

If a new upgrade is found, it starts to download the upgrade. A progress bar indicates the remaining download progress. When download completes with success a message is displayed for reboot to activate new software. Press OK to continue with the reboot operation.

2) 3.AM search and upgrade mode

If Automatic scanning in Upgrade Options menu is enabled, TV wakes up at 03:00 and searches broadcast channels for new software upgrade. If new software is found and downloaded successfully, with next power up TV opens with new software version.

Note on reboot operation: Reboot is the last step in software upgrade operation if download of new software is finished successfully. During reboot TV makes final initializations. In reboot sequence panel power is closed and front led indicates the activity with blinking. Around 5 minutes later TV restarts with new software activated.

If your TV fails to restart in 10 minutes, unplug power for 10 minutes and re-plug again. TV should open with new software safely. If you still can not get TV working, please kindly repeat unplug and plug sequence a few times more. If your set still can not operate, please call the service personnel to fix the problem for you.

⚠ CAUTION: While led is blinking during reboot do not unplug your TV's power. Doing this may cause your TV not to re-open again and can only be fixed by service personnel.

✎ NOTE: A software update is dependent on whether the TV stations of each country support it.

Licence Notifications

This product incorporates copyright protection technology that is protected by U.S. patents and other intellectual property rights. Use of this copyright protection technology must be authorized by Rovi Corporation, and is intended for home and other limited viewing uses only unless otherwise authorized by Rovi Corporation. Reverse engineering and disassembly are prohibited.



Product Guarantee

This product is guaranteed against manufacturing defects for a period of



This product is guaranteed for twelve months from the date of original purchase. Any defect that arises due to faulty materials or workmanship will either be replaced, refunded or repaired free of charge where possible during this period by the dealer from whom you purchased the unit.

The guarantee is subject to the following provisions:

- The guarantee does not cover accidental damage, misuse, cabinet parts, knobs or consumable items.
- The product must be correctly installed and operated in accordance with the instructions contained in this manual.
- It must be used solely for domestic purpose.
- The guarantee will be rendered invalid if the product is re-sold or has been damaged by inexpert repair.
- Specifications are subject to change without notice.
- The manufacturer disclaims any liability for the incidental or consequential damages.
- The guarantee is in addition to, and does not diminish your statutory or legal rights.
- In the event of a problem with the product within the guarantee period call the **Customer Helpline: 0345 604 0105**.

Guarantor: Argos Ltd
489 - 499 Avebury Boulevard
Central Milton Keynes
MK9 2NW



For any help concerning set up and use of your TV please call the Customer Helpline: 0345 604 0105